

**Educacionais
de
Engenharia de Operação**

**Mobiliário Padrão
do
Prodem**

MEC/DEM

PRODEM

Programa de Desenvolvimento do Ensino Médio

1975

Livros Grátis

<http://www.livrosgratis.com.br>

Milhares de livros grátis para download.

M O B I L I Á R I O P A D R ã O

D O

P R O D E M

Obs.: A mesa código DOS-E é idêntica a mesa código 004, exceto a forração do tampo, que no primeiro caso é de laminado melamínico e no segundo folheado em louro jacarandá.

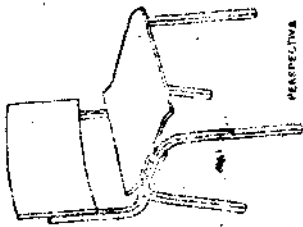

TURO DE AÇO
QUADRODO 20x20 MM

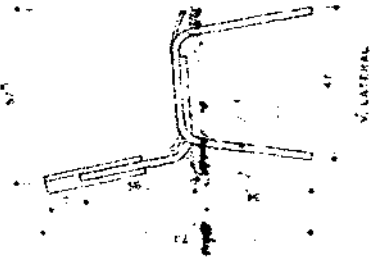
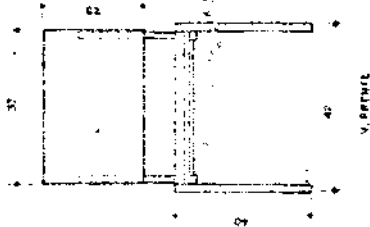

SECRETARIA EXECUTIVA - GERÊNCIA DE APOIO ADMINISTRATIVO

NEC - PRODEM

CADERNA FRIA SIBRAÇÓEMPILHÁVELS - EMPILHÁVEL

CODIGO

001

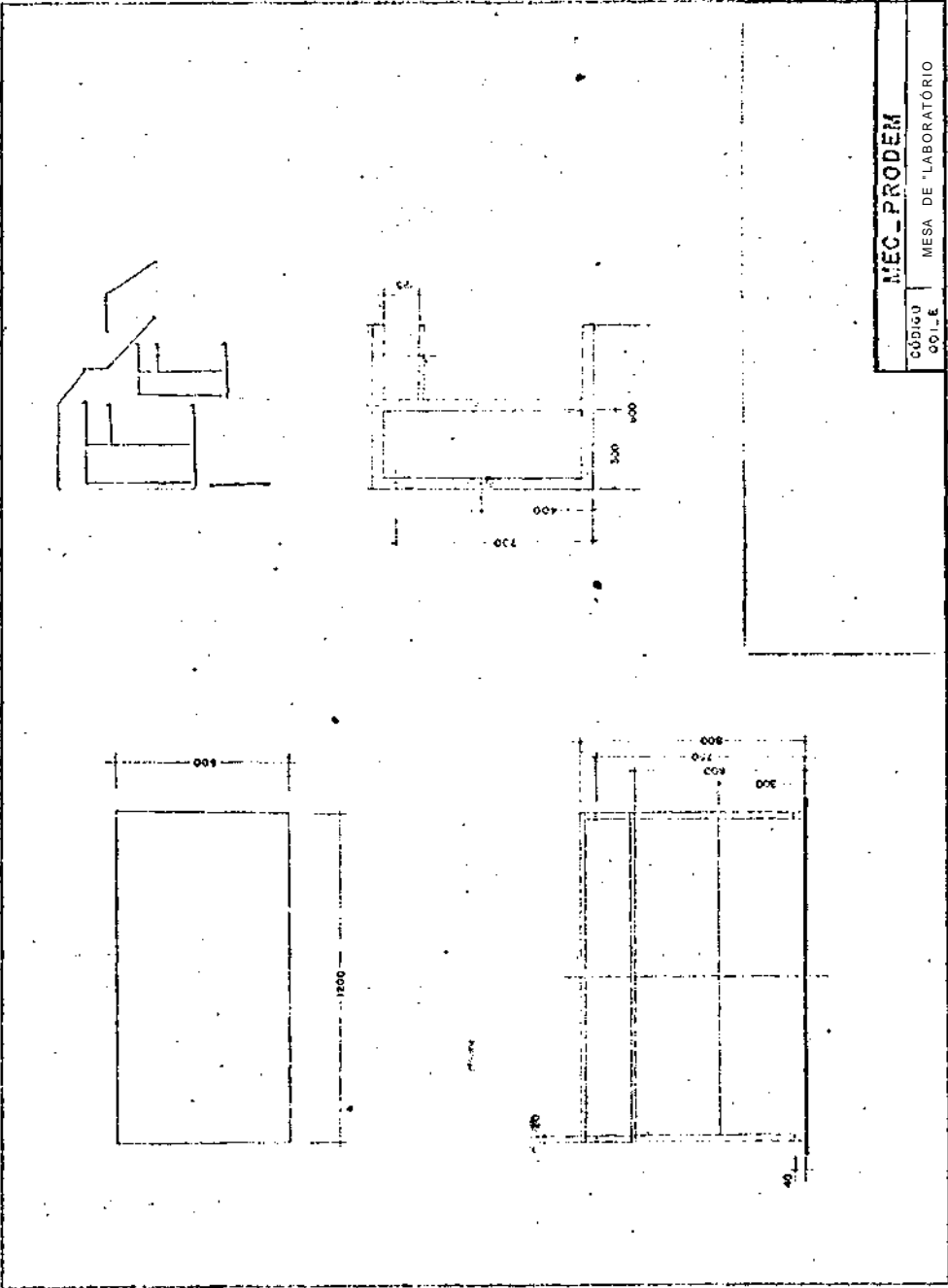

MEC-PRODEM

MESA DE LABORATÓRIO

CÓDIGO
001.E

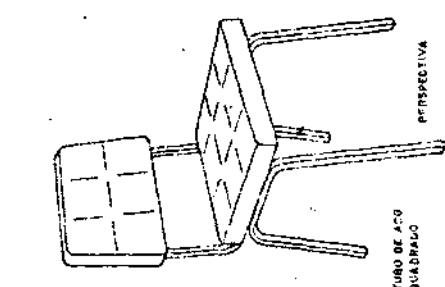

TURO DE AÇO QUADRADO

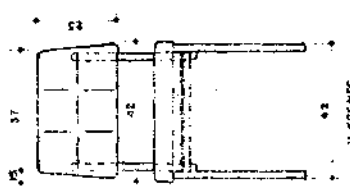

V. FRENTE

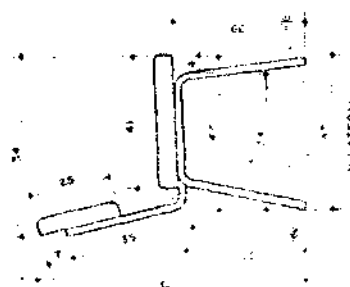

V. LATERAL

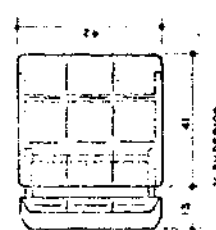

V. SUPERIOR

SECRETARIA EXECUTIVA - GERÊNCIA DE APOIO ADMINISTRATIVO

MEC - PRODEMA	
173160	CADEIRA FIXA SIBRÃO CFMI
002	

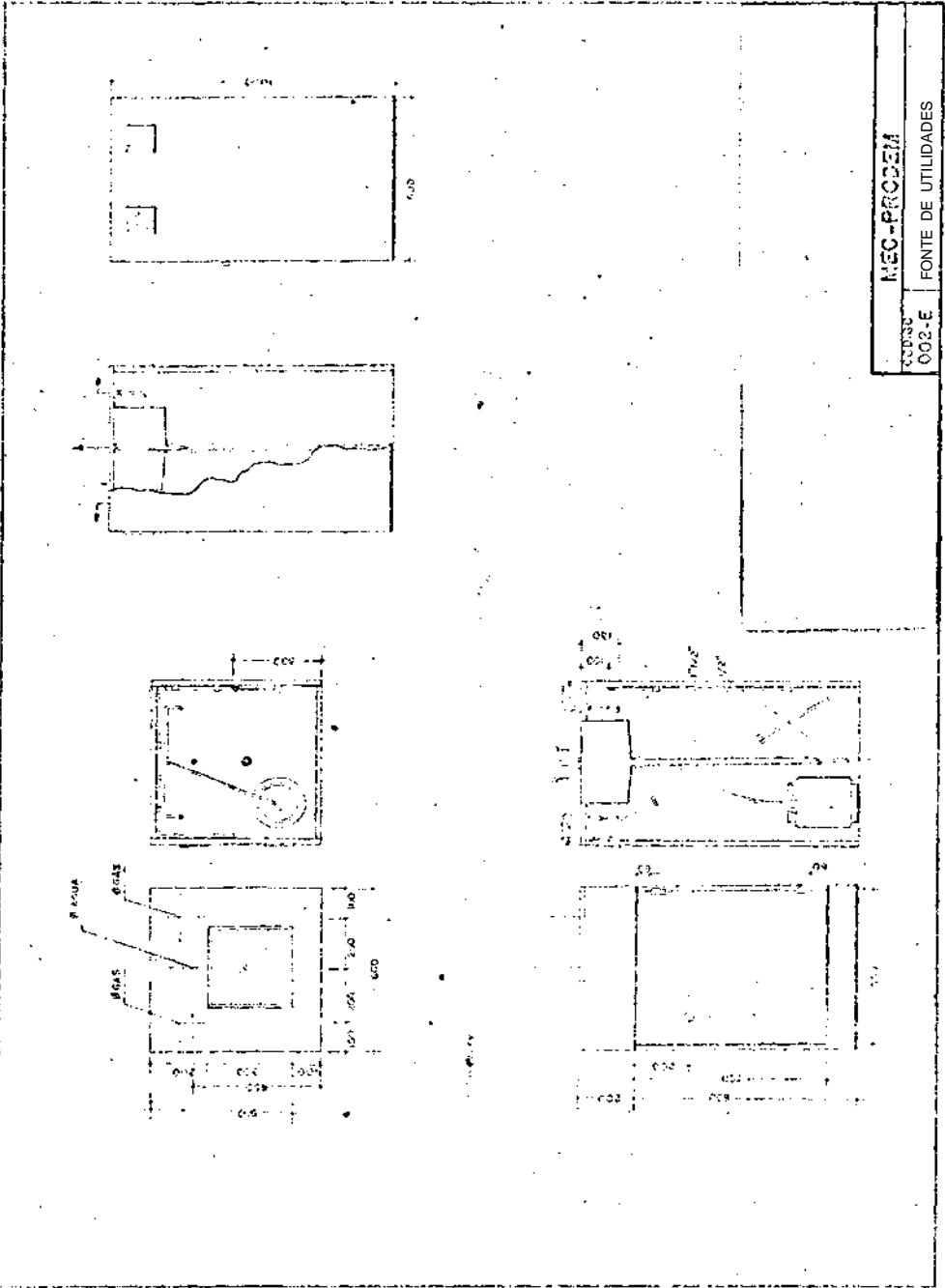

PROJETO MEC-PRODEM
 002-E FONTE DE UTILIDADES

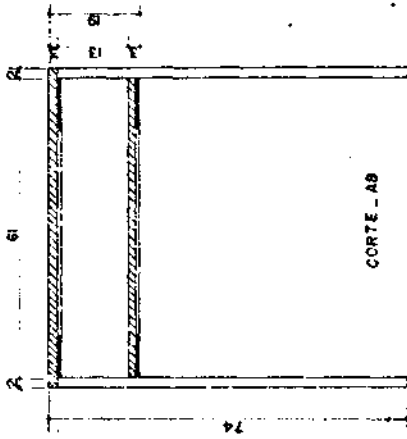

CORTE - AB

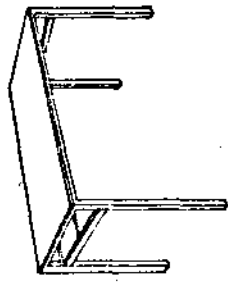
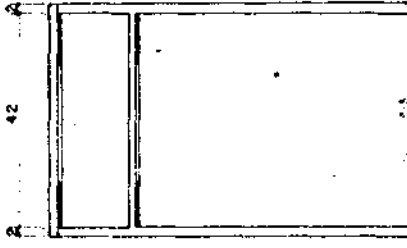
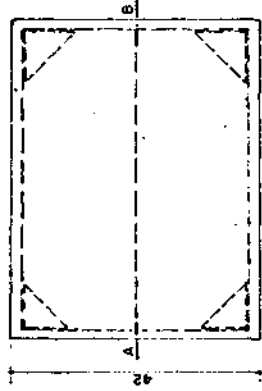

MEC - PRODEM

MESA DE TRABALHO REFORÇADA
(ALUNOS)

CÓDIGO
003

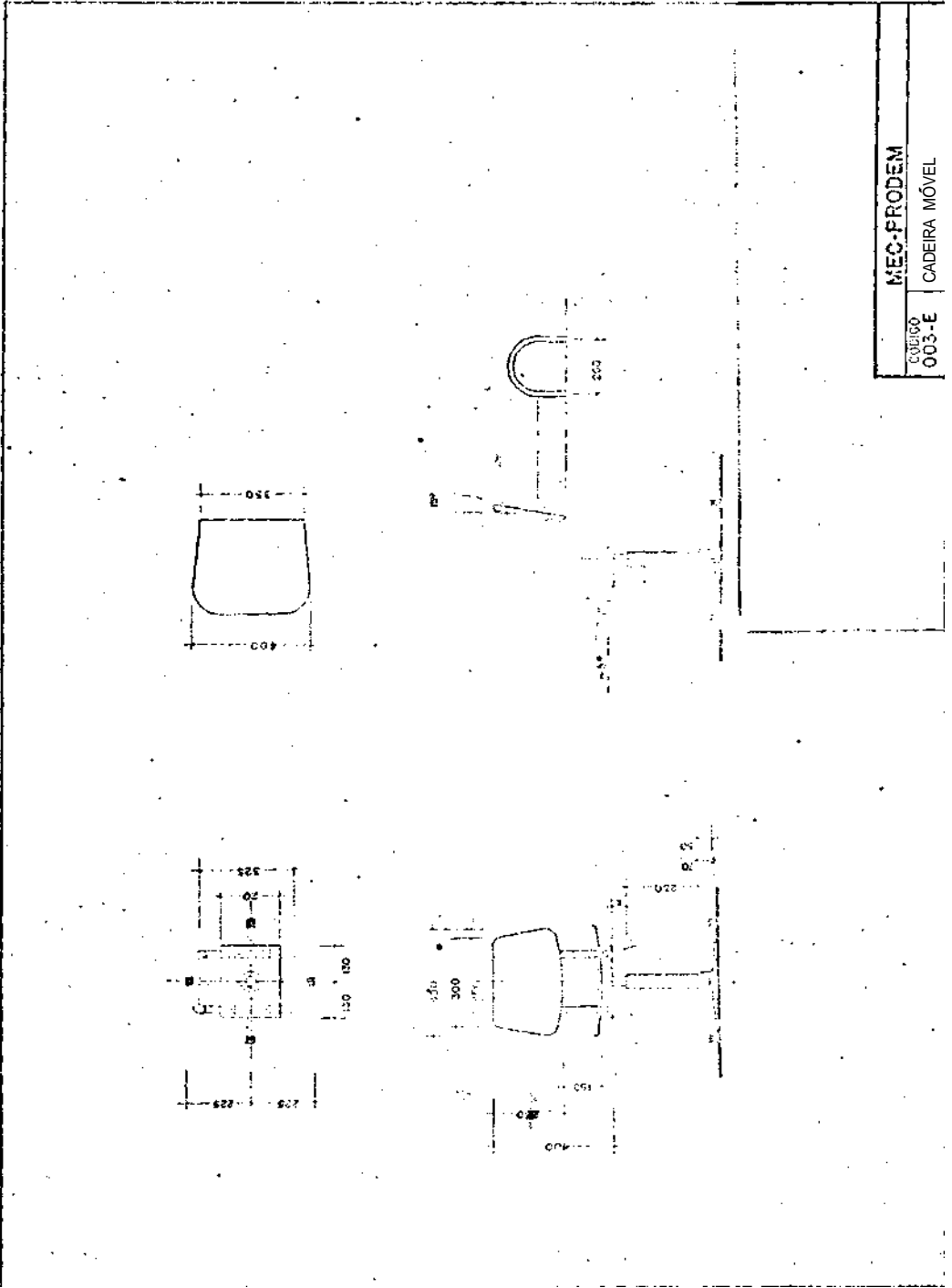

MEC-PRODEM	
CADUCO	003-E
CADEIRA MÓVEL	

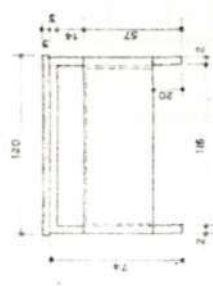

V. FRENTE

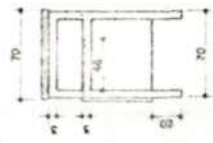

V. LATERAL



V. SUPERIOR

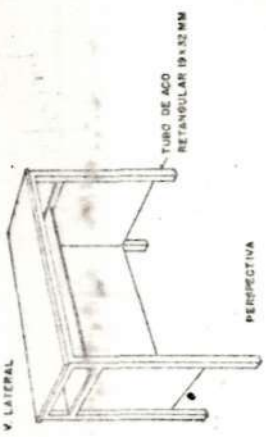

PERSPECTIVA

SECRETARIA EXECUTIVA - SEERÁDIA DE APOIO ADMINISTRATIVO

MEC - PRODEM	
CÓDIGO:	MESA (AUXILIAR) DE TRABALHO (PROFESSOR)
004	

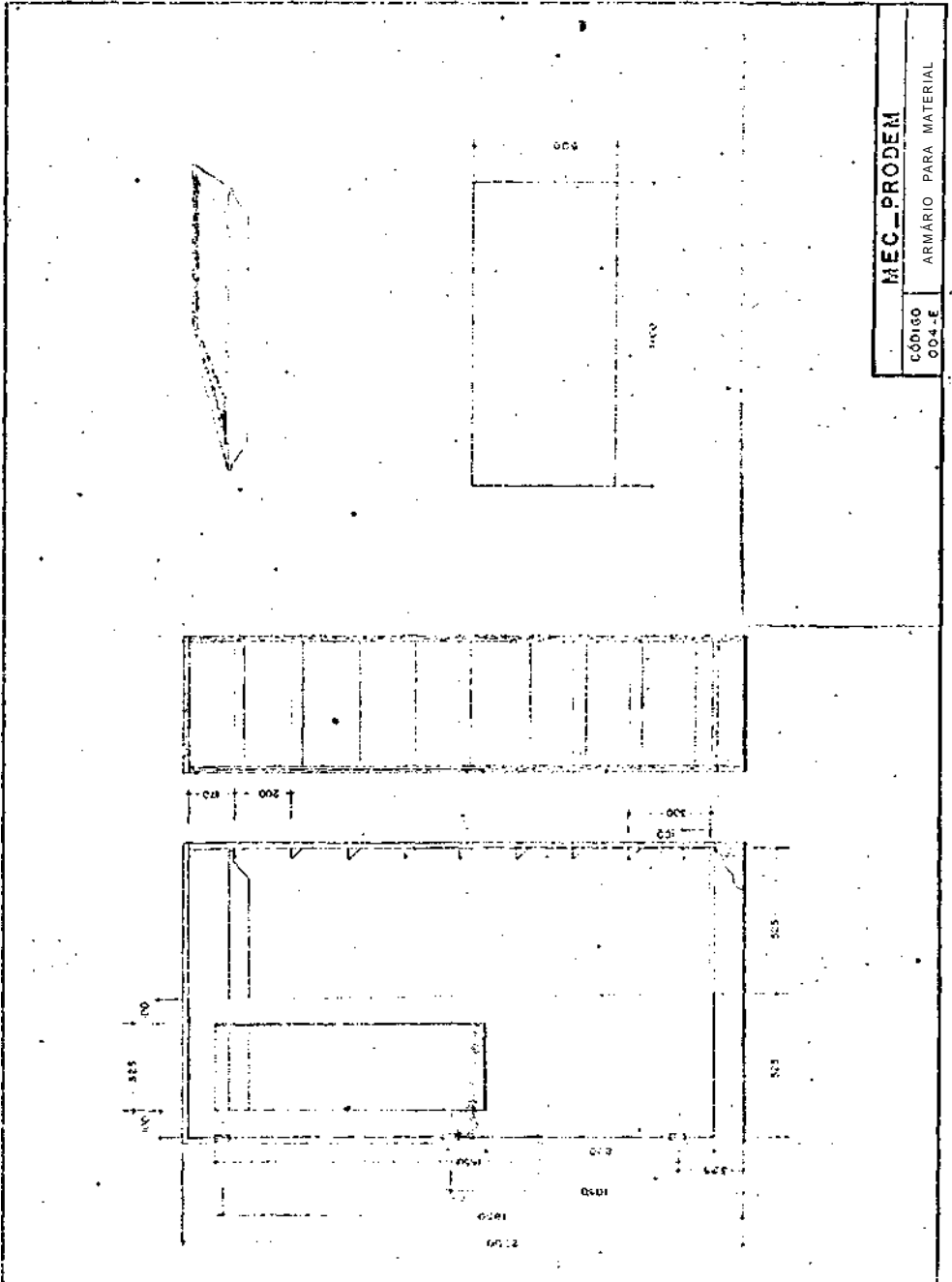

FRANCO

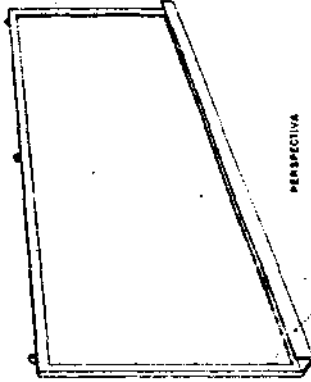

PERSPECTIVA

VERME

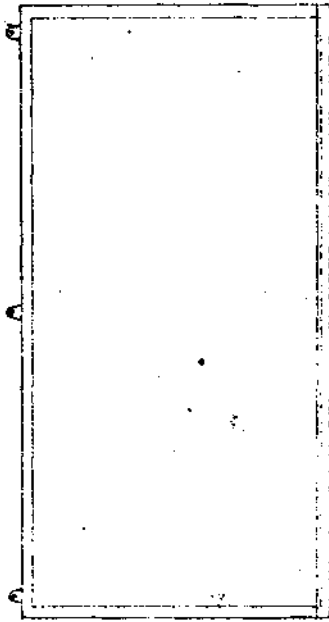

V.FRONTA



300

V. LADO

SECRETARIA EXECUTIVA - GERENCIA DE APOIO ADMINISTRATIVO

MEC - PRODEA

CODIGO

005

QUADRO NEGRO

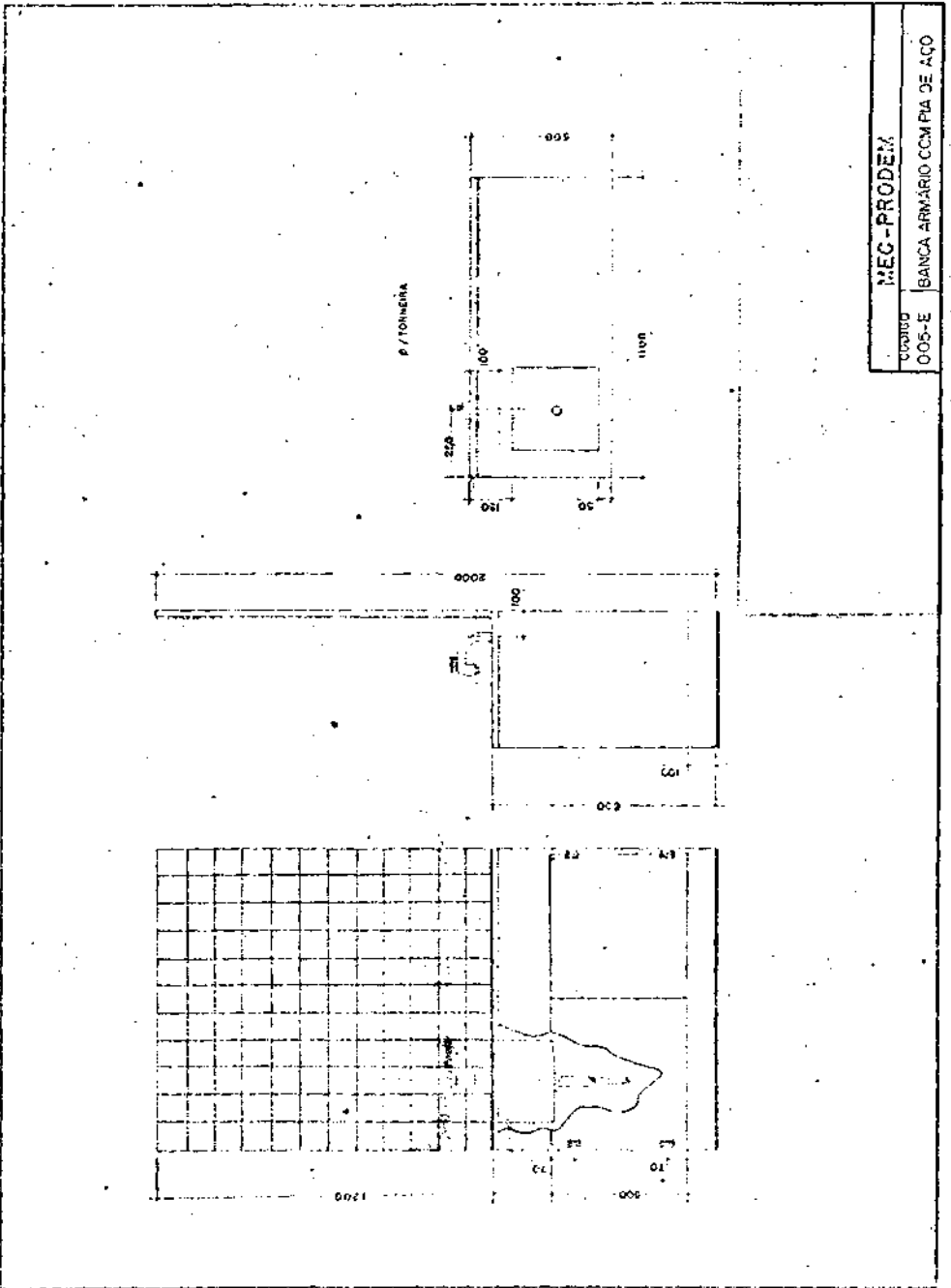

ESPALHO

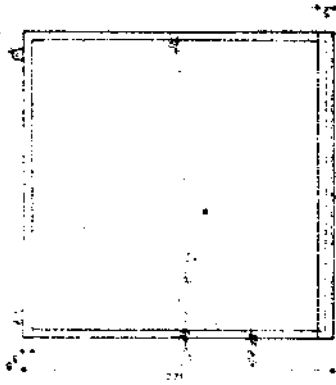

V. FRENTE

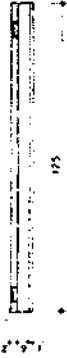

V. SUPERIOR

125

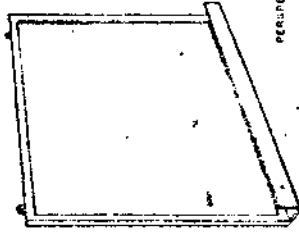

PERSPECTIVA

V. VENTRAL

SECRETARIA EXECUTIVA - GERENÇIA DE APOIO ADMINISTRATIVO

FAEC - PRODEM

CODIGO

006

QUADRO NEGRO

Setor

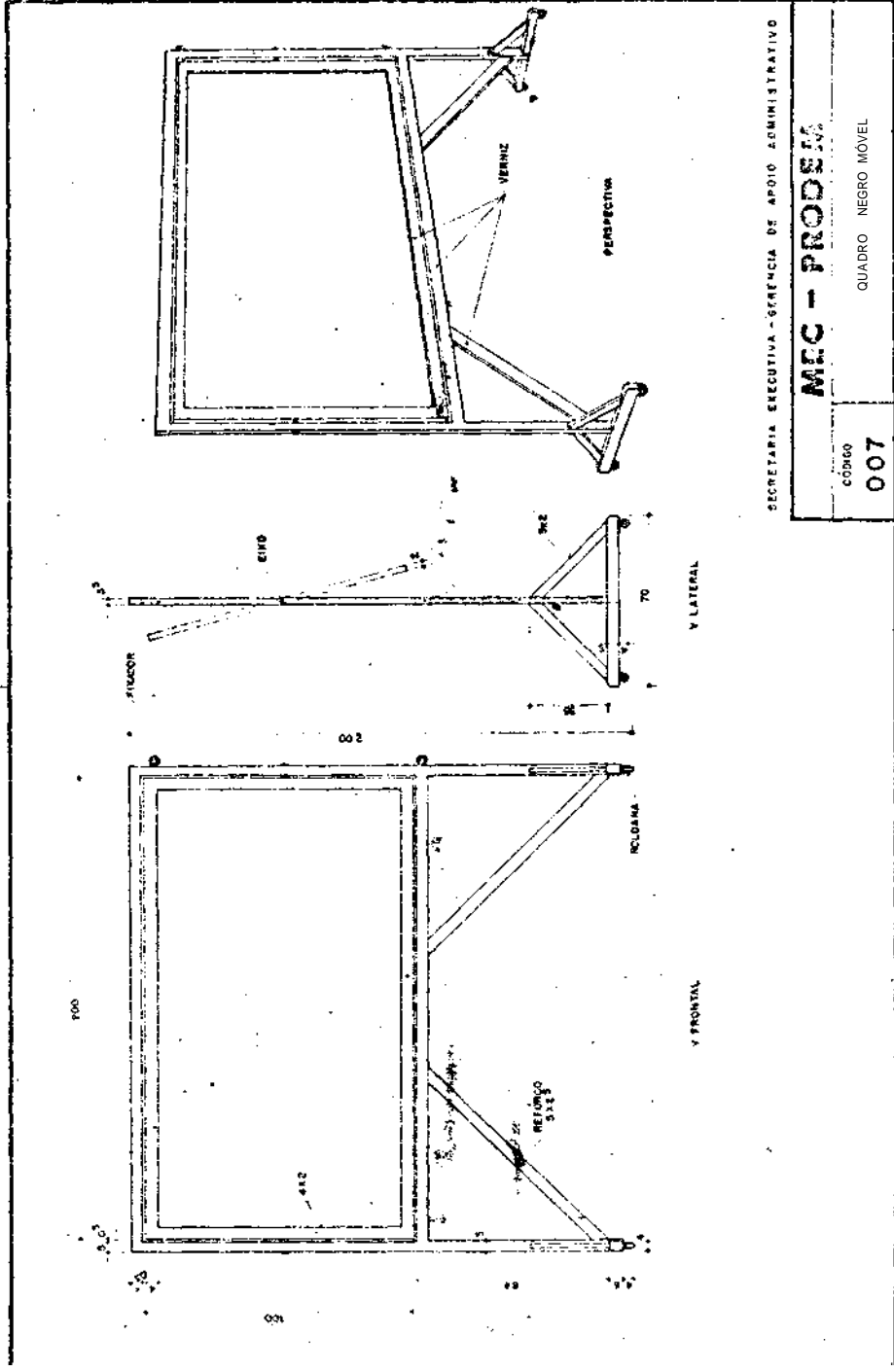

SECRETARIA EXECUTIVA - GERENCIA DE APOIO ADMINISTRATIVO

MEC - PRODEM

CODIGO 007 QUADRO NEGRO MÓVEL

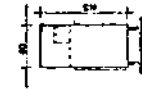

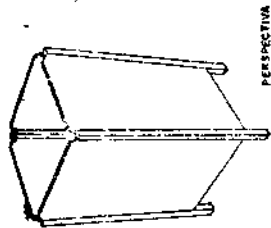
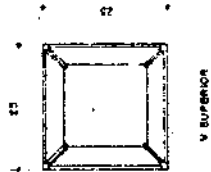
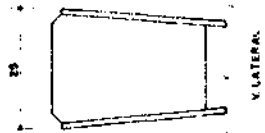
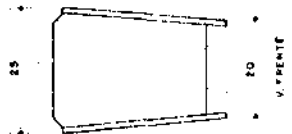

SECRETARIA EXECUTIVA - GERENCIA DE APOIO ADMINISTRATIVO

MEC - PRODEM

CODIGO

008

CESTO P/PAPEIS

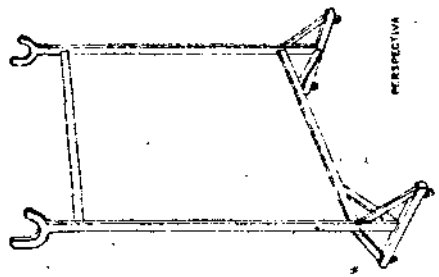

PERSPECTIVA

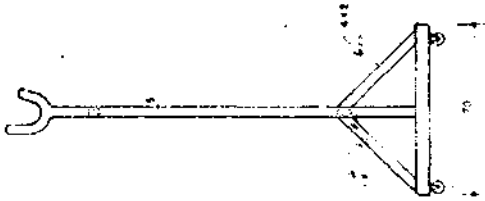

V LATERAL

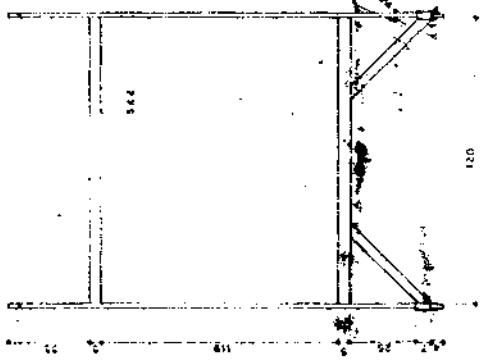

V FRENTE

VERMIZ

SECRETARIA EXECUTIVA - GERENCIA DE APOIO ADMINISTRATIVO

MEC - PRODEJA

SUPORTE PQUADRO MURAL

00900
009

BR/ART

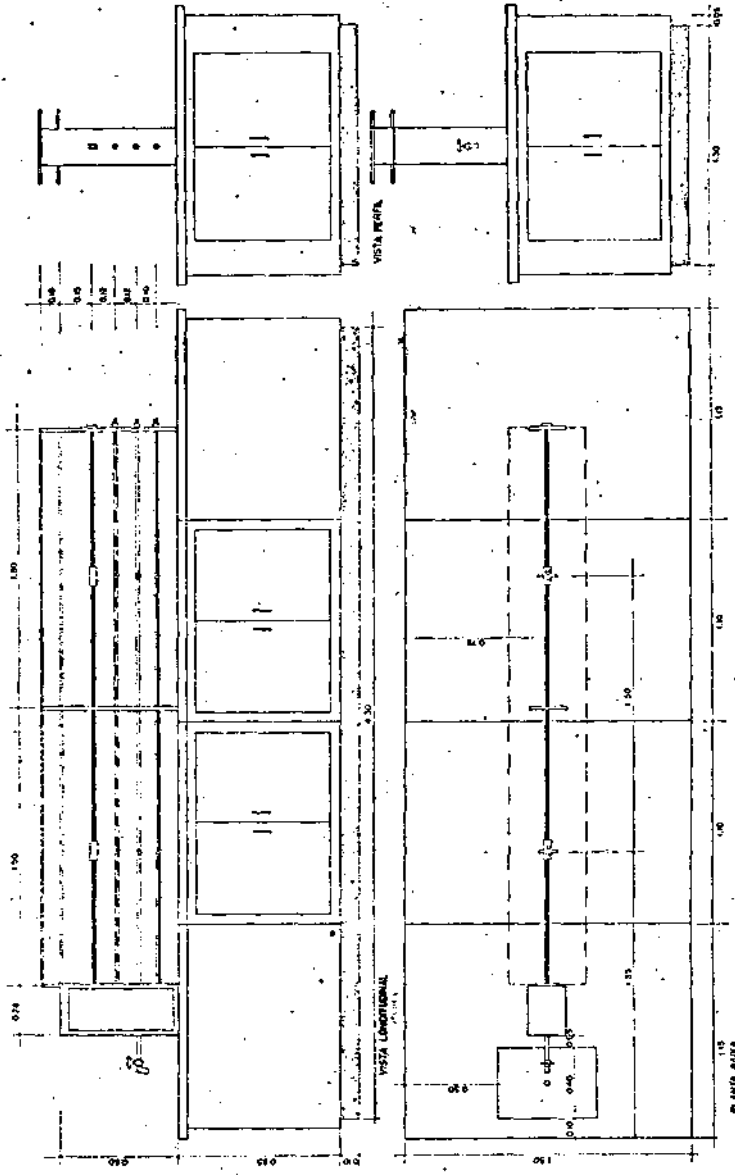

NOME: MEC-PRODEM
 COLEGIO: INSTITUTO DE LUTERIA

115
PLANTA CABO

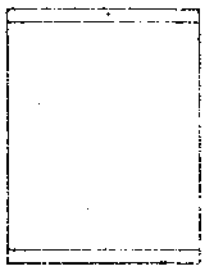

V FRENTE

TIP UNIDAD

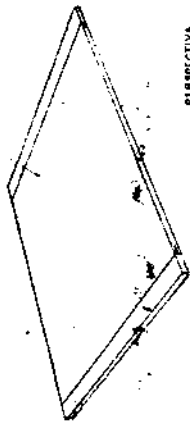

PERSPECTIVA

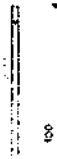

V SUPERIOR

SECRETARIA EJECUTIVA - GERENCIA DE APOYO ADMINISTRATIVO

REC - PRODEM

CÓDIGO

010

FRANCHETA

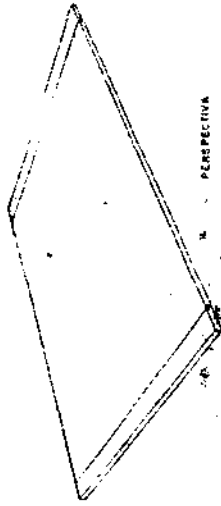
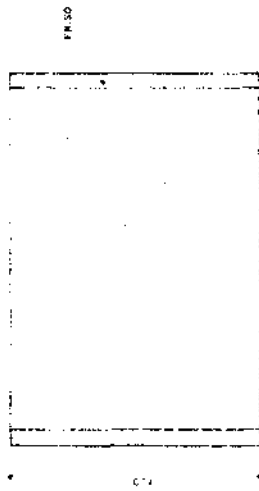

SECRETARIA EXECUTIVA - BURELIA DE APOIO ADMINISTRATIVO

MEC - PRODEM

CODIGO:

011

PRANCHETA

10/1/81

VERNIZ

VERNIZ

PIÉS DE BORRACHA

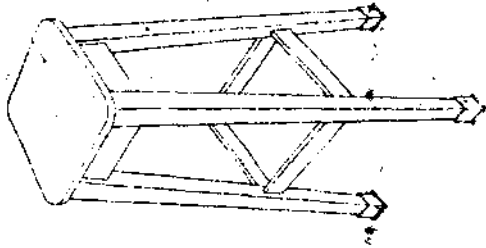

PERSPECTIVA

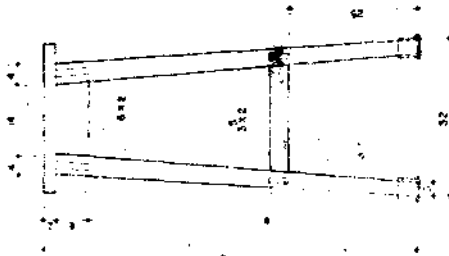

V. FRENTE

CANTO ARREDONDO

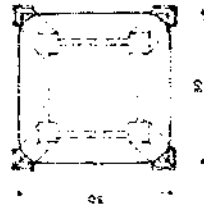

V. SUPERIOR

SECRETARIA EJECUTIVA - GERENCIA DE APOYO ADMINISTRATIVO

MEC - PRODEM

CÓPIA

012

BANCO

VERMIZ

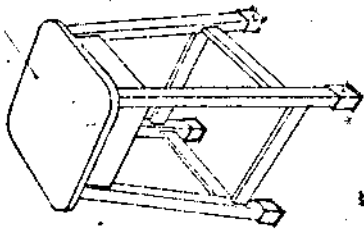

PIES DE BOMBACHA

PERSPECTIVA

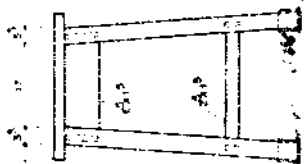

V. FRENTE

CANTO ARREDONDAO



V. SUPERIOR

SECRETARIA EXECUTIVA - GERENCIA DE APOIO ADMINISTRATIVO

MEC - PRODEM

CÓDIGO

013

BANQUINHO

SECRET

SECRETARIA EXECUTIVA - SERENÇA DE APOIO ADMINISTRATIVO.

MEC - PRODEA

CÓDIGO

014

ARMÁRIO MATERIAL EXPEDIENTE

5/1/81

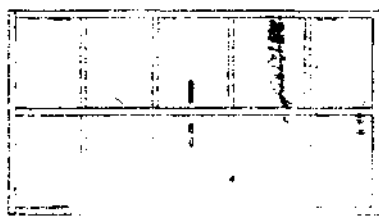
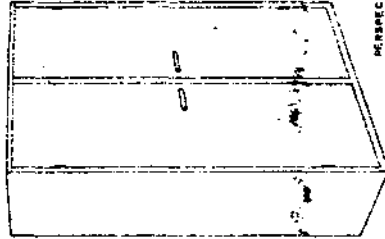

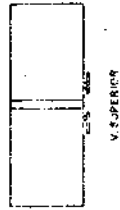
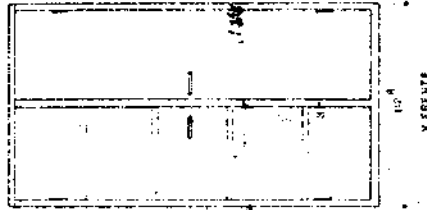
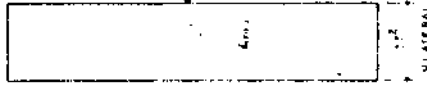
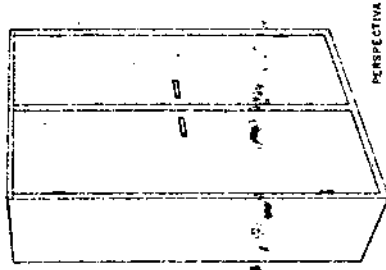

SECRETARIA EXECUTIVA - GERENCIA DE APOIO ADMINISTRATIVO

MEC - PRODEM

CÓDIGO
015
ARMÁRIO MATERIAL LIMPEZA

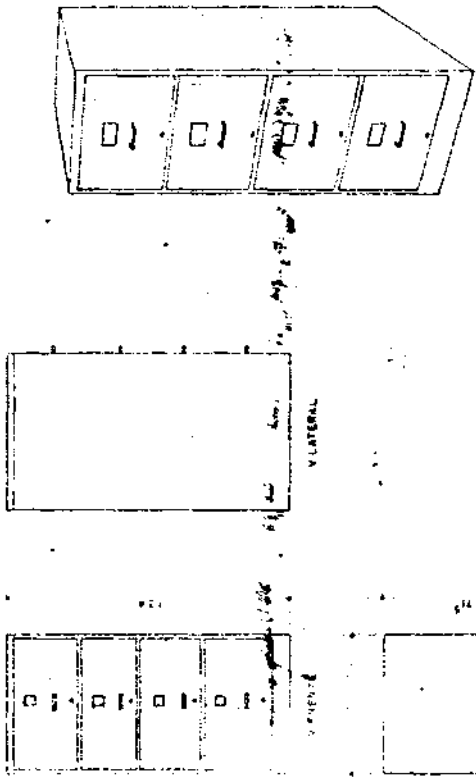

SECRETARIA EJECUTIVA - GERENCIA DE APOYO ADMINISTRATIVO

MEC - PRODEM

ARQUIVO/DOCUMENTOS

016

TAPO DE AÇO INOXIDÁVEL

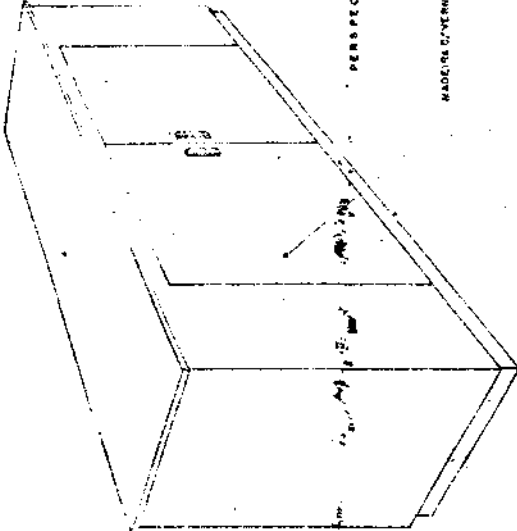

PERSPECTIVA

MADEIRA D'ÁFRICA

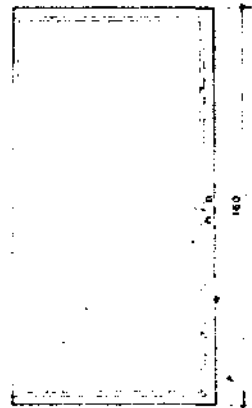
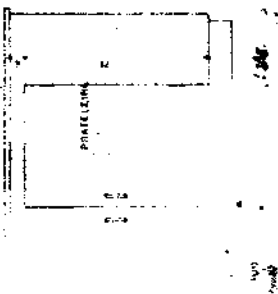

SECRETARIA EXECUTIVA - GERÊNCIA DE APOIO ADMINISTRATIVO

MEC - PRODEM

CÓDIGO: BAPEC/ANDON C/ TAMPO DE AÇO INOXIDÁVEL

017

se fert

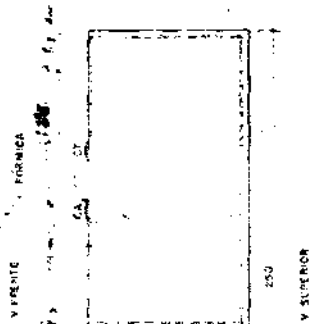
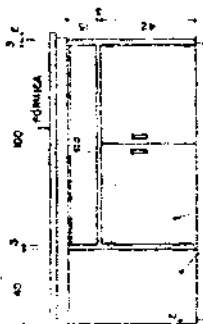
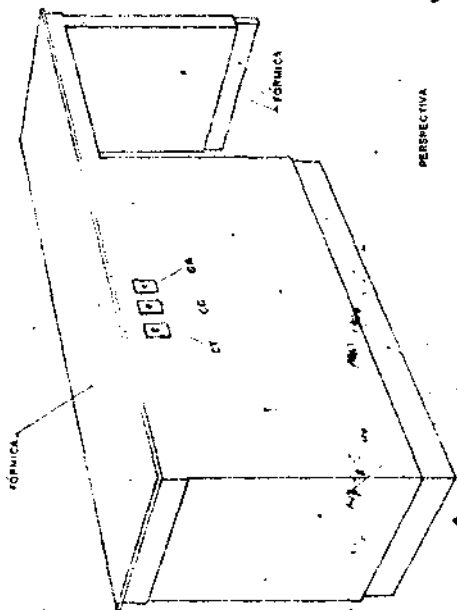

SECRETARIA EXECUTIVA - GERENCIA DE APOIO ADMINISTRATIVO

MEC - PRODEA

BANCADA PARA PROFESSOR
(LAB - DEMONSTRAÇÃO)

CODIGO
018

5/1/77

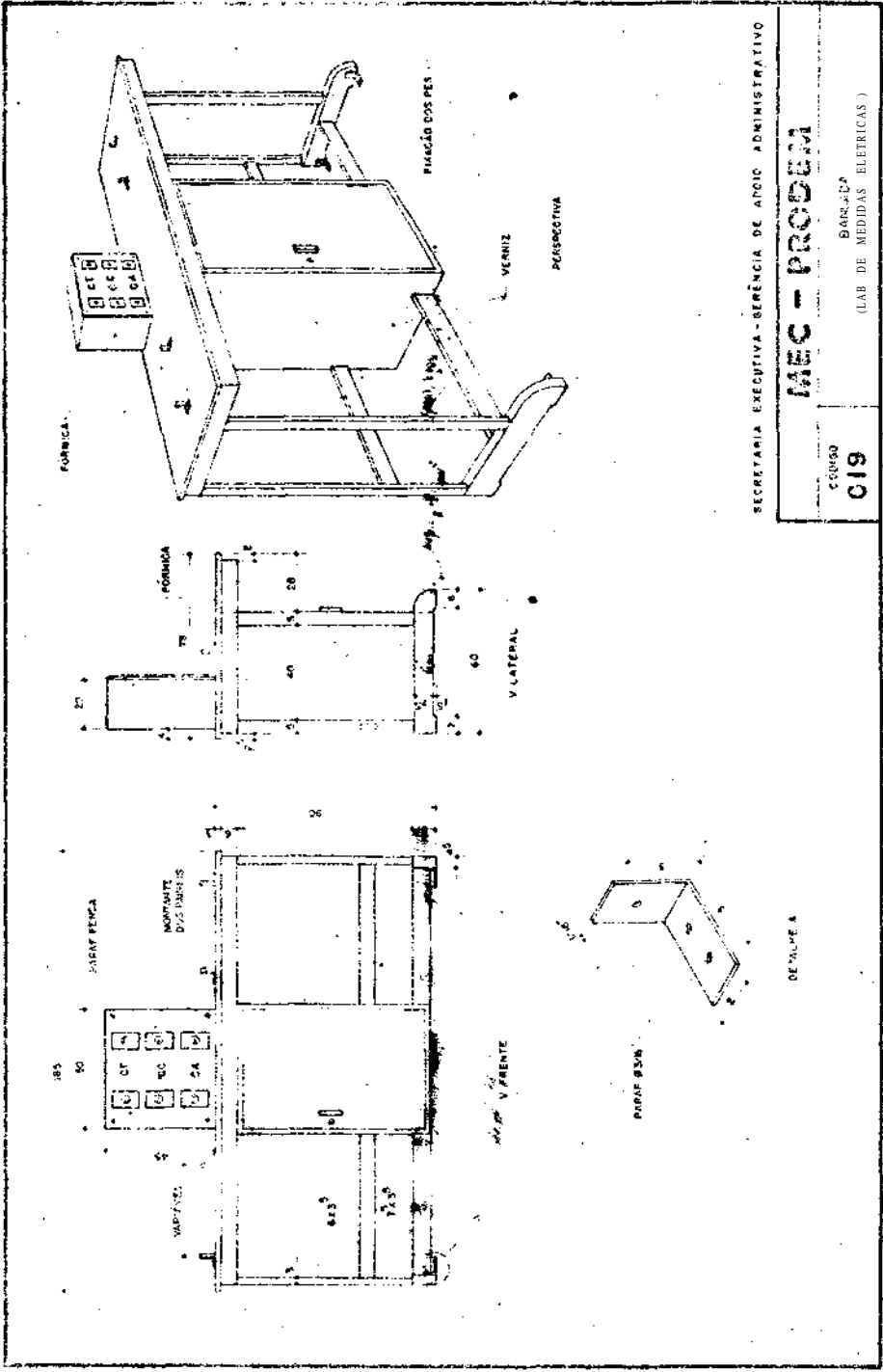

SECRETARIA EXECUTIVA - GERENCIA DE APOIO ADMINISTRATIVO

MEC - PRODEM
 COMISSÃO
C19
 BANDEIRA
 (LAB. DE MEDIDAS ELETRICAS)

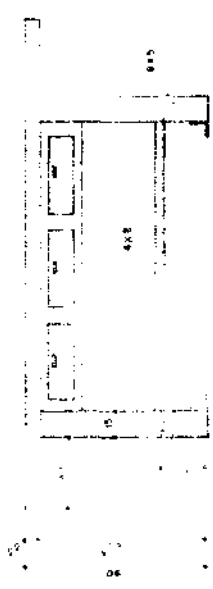

V SUPERIOR

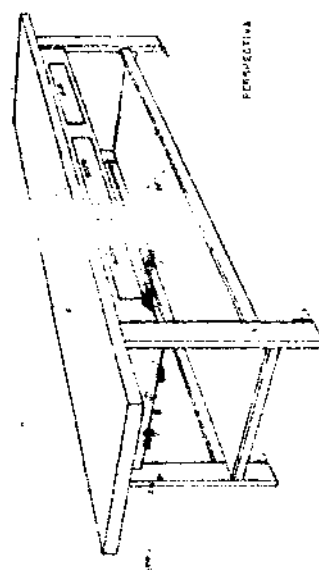

PERSPECTIVA

VERRIZ

VERRIZ

SECRETARIA EJECUTIVA - SERVICIO DE APOYO ADMINISTRATIVO

MEC - PRODEM

BANCA PARA MONTAJE MEC-TADEM

CÓDIGO

020

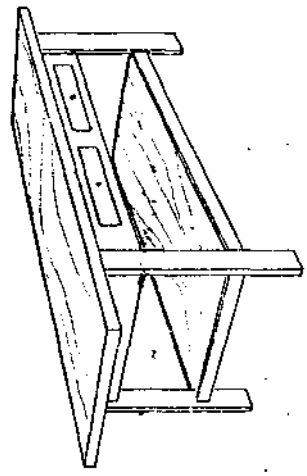
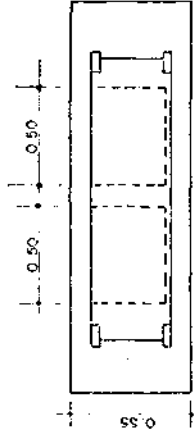
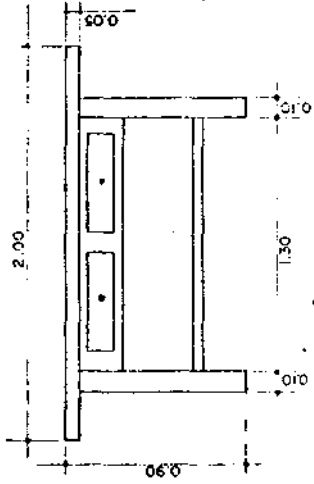

MEC - FRODEM	
CÓDIGO	BANCADA PARA AJUSTAGEM
020_A	

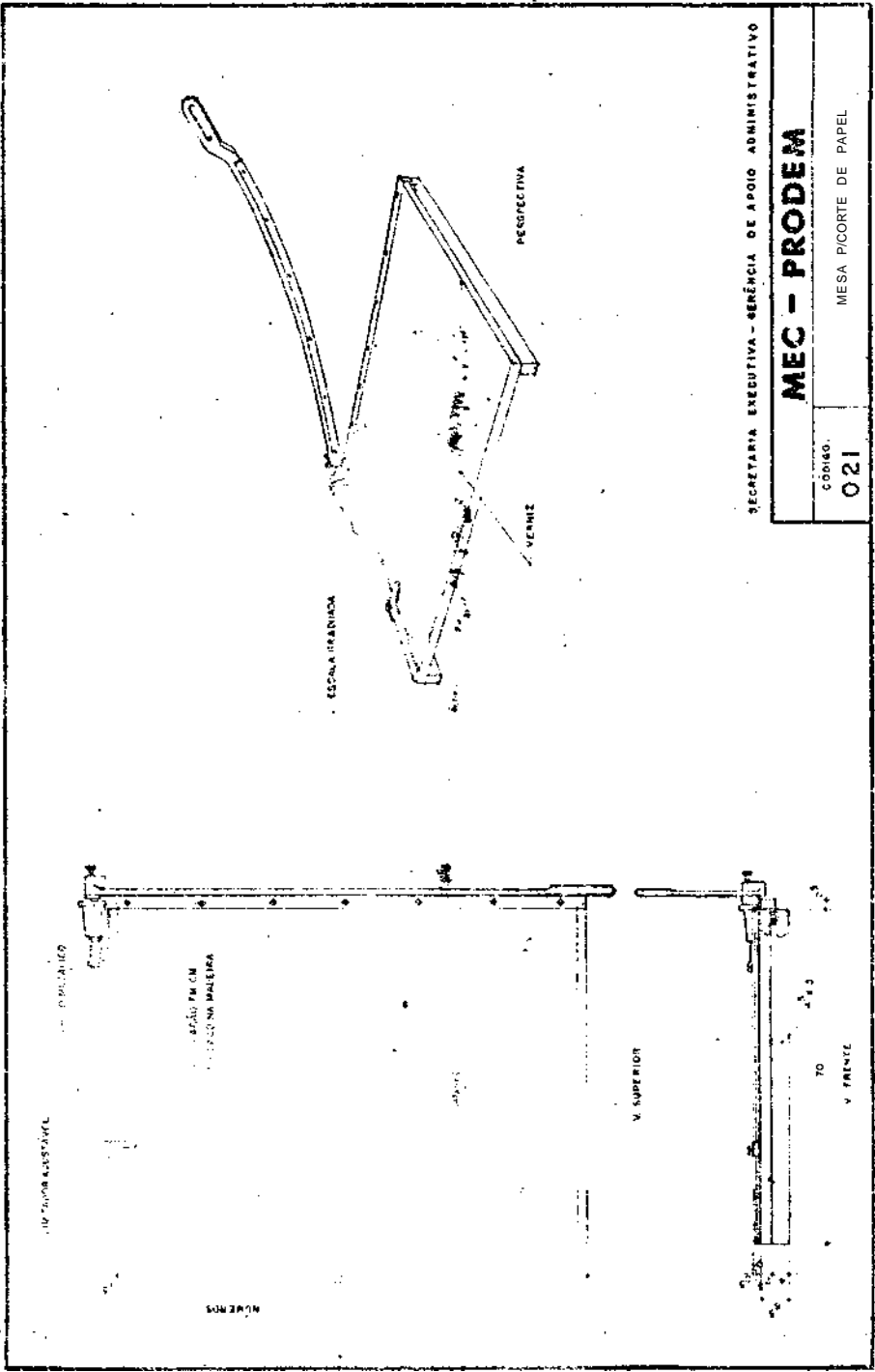

SECRETARIA EXECUTIVA - GERÊNCIA DE APOIO ADMINISTRATIVO

MEC - PRODEM	
CODIGO.	MESA PICORTE DE PAPEL
021	

BR/2002

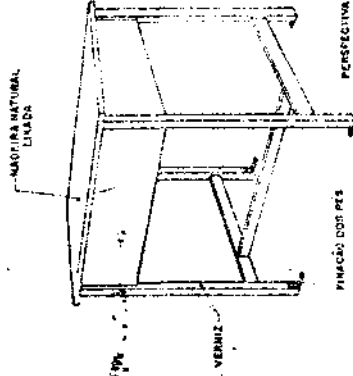
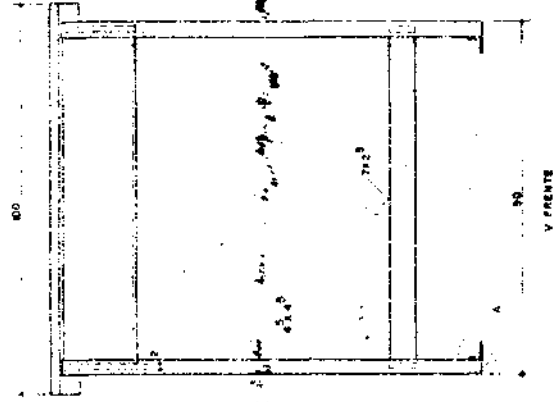
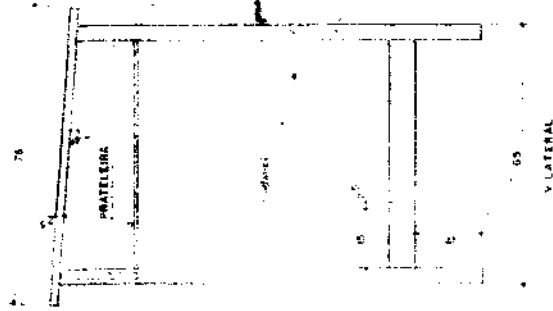

PARAF 53/10



SECRETARIA EXECUTIVA - GERÊNCIA DE APOIO ADMINISTRATIVO

MEC - PRODEM

CCOMO

022

MESA CL DEZENHO

85191

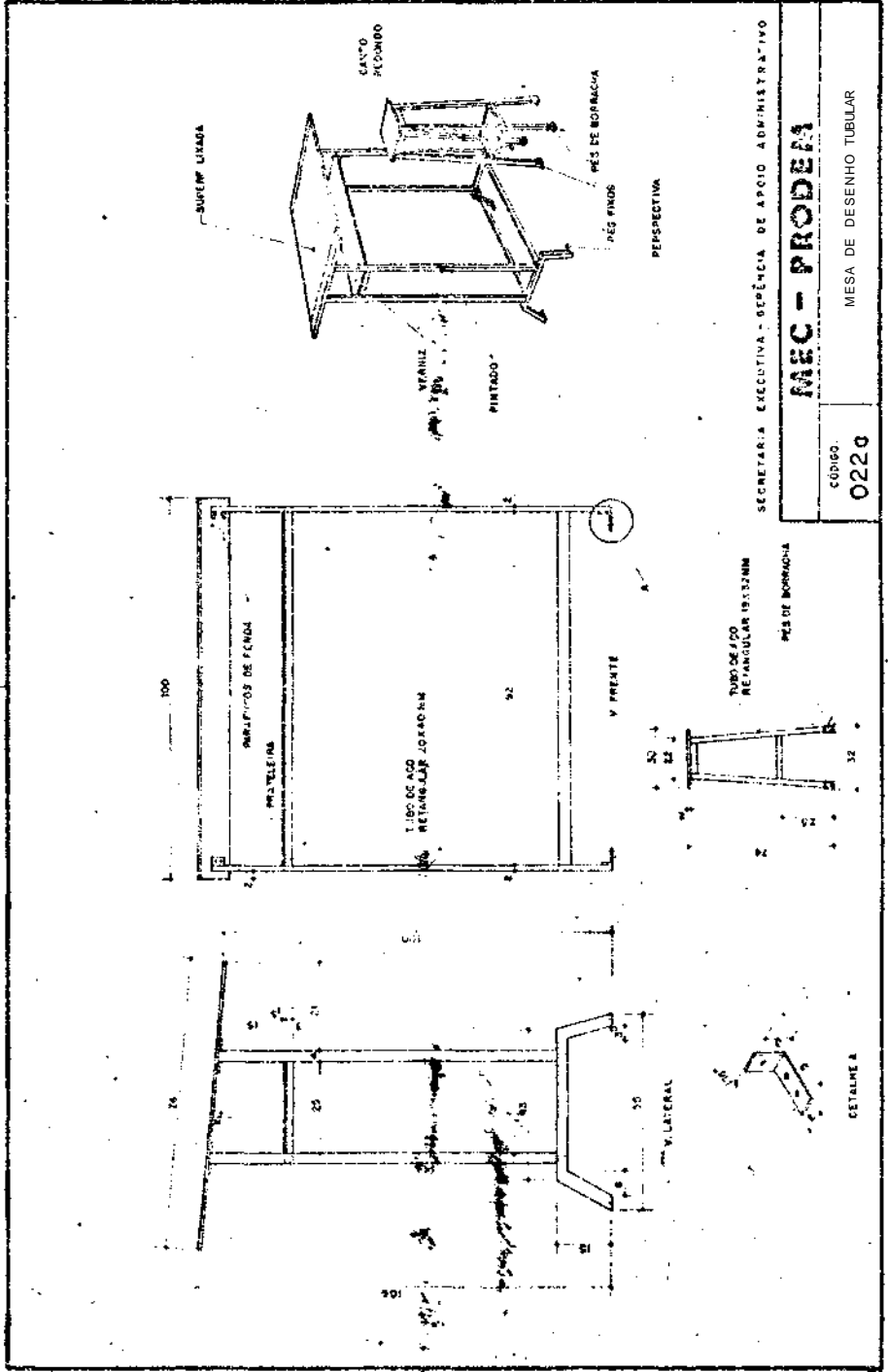

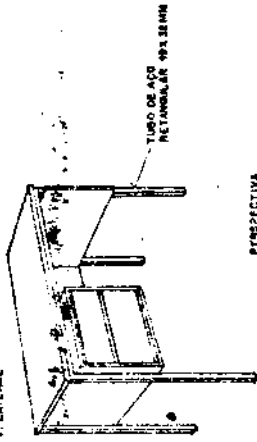
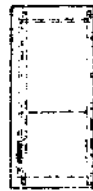
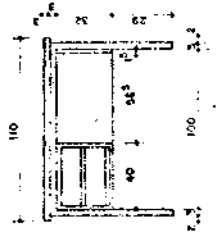
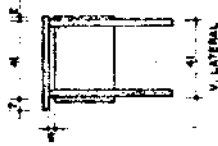

SECRETARIA EXECUTIVA - SERÇIA DE APOIO ADMINISTRATIVO

MEC - PRODEM

CODIGO

023

MESA ESCRIVANINHA-M-FM1-1

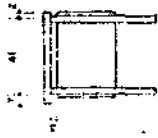

Handwritten notes:
2,3
100
20
V. SUPERIOR
V. INFERIOR



V SUPERIOR

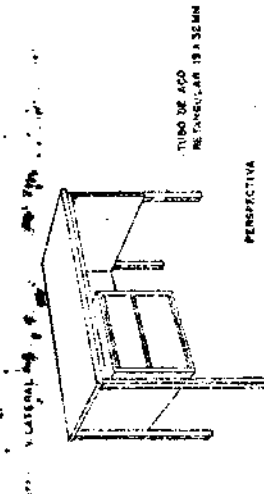

TUBO DE AÇO
RETOBULAR 19 X 32MM

PERSPECTIVA

SECRETARIA EXECUTIVA - SECRETARIA DE APOIO ADMINISTRATIVO

MEC - PRODEM

CÓDIGO
024

MESA P/MÁQUINA-MM-FM1-1

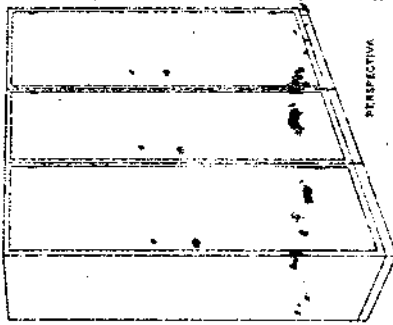

PERSPECTIVA

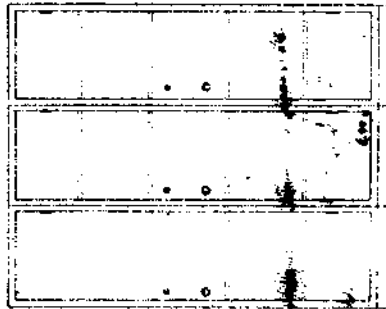

138



V SUPERIOR

SECRETARIA EJECUTIVA - GERENCIA DE APOYO ADMINISTRATIVO

MEC - PRODEM

CÓDIGO
025

ARMARIO-MATERIAS PRIMAS

8/1/87

QUADRO DE REGISTRO

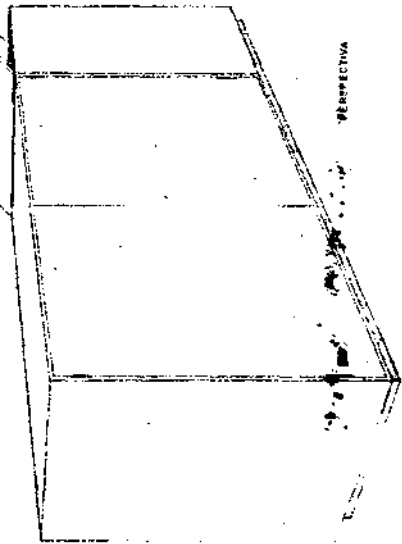

PERPECTIVA

REGISTRO

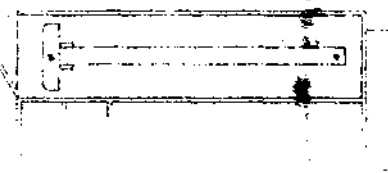

PAVIMENTO DE FÓSSA

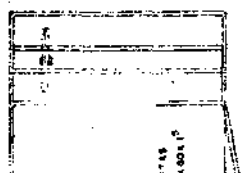

SUP. 40 PAVIMENTOS
DIMENSÕES 100x80x10

SECRETARIA EXECUTIVA - GERENCIA DE APOIO ADMINISTRATIVO

MEC - PRODEM

CODIGO

ANEXO 17 PLANILHAS

025

V. 1/10

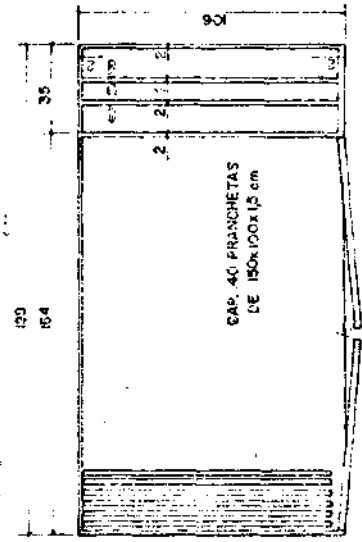
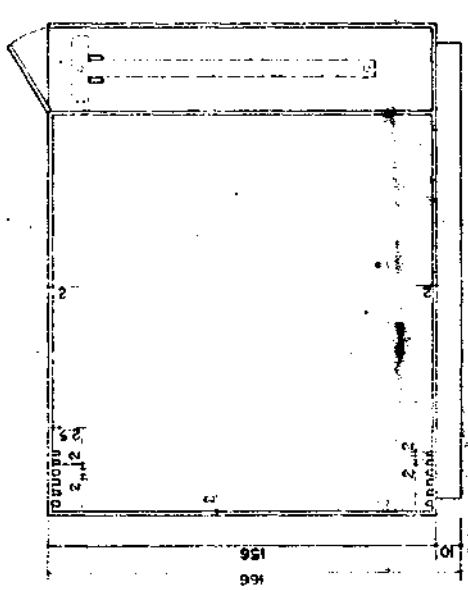
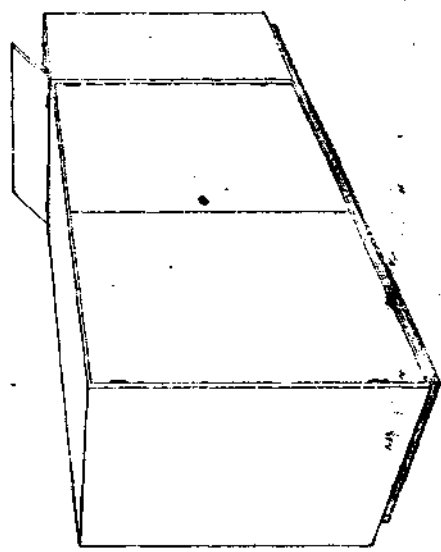

MEC_PRODEM
CÓDIGO 026-A
ARMARIO P/ PRANCHETAS

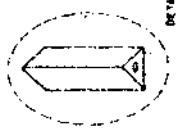
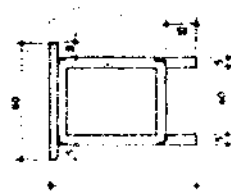
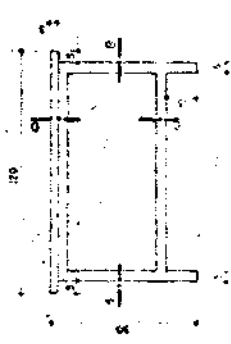

DETALHE A

CORTE AB

CORTE CD

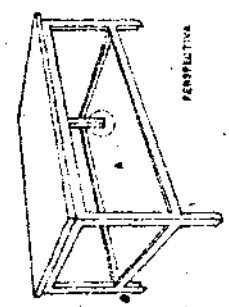
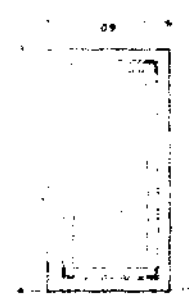

PERSPECTIVA

PERFIL L
EXTERNO

PERFIL L
INTERNO

SECRETARIA EXECUTIVA - GERENCIA DE APOIO ADMINISTRATIVO

MEC - PRODEA	
BANCA PARA MESMILE FURADEIRA	FURADEIRA
CCOD: 027	

REVEST FURNICA



ALUMINIO

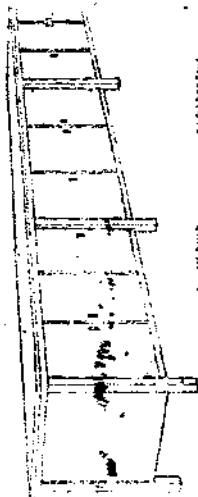

CANTO AMBROSZADO



V SUPERIOR

SECRETARIA EXECUTIVA - GERENCIA DE APOIO ADMINISTRATIVO

MEC - PRODEM

CODIGO

028

BANCADA PARA PROFESSOR

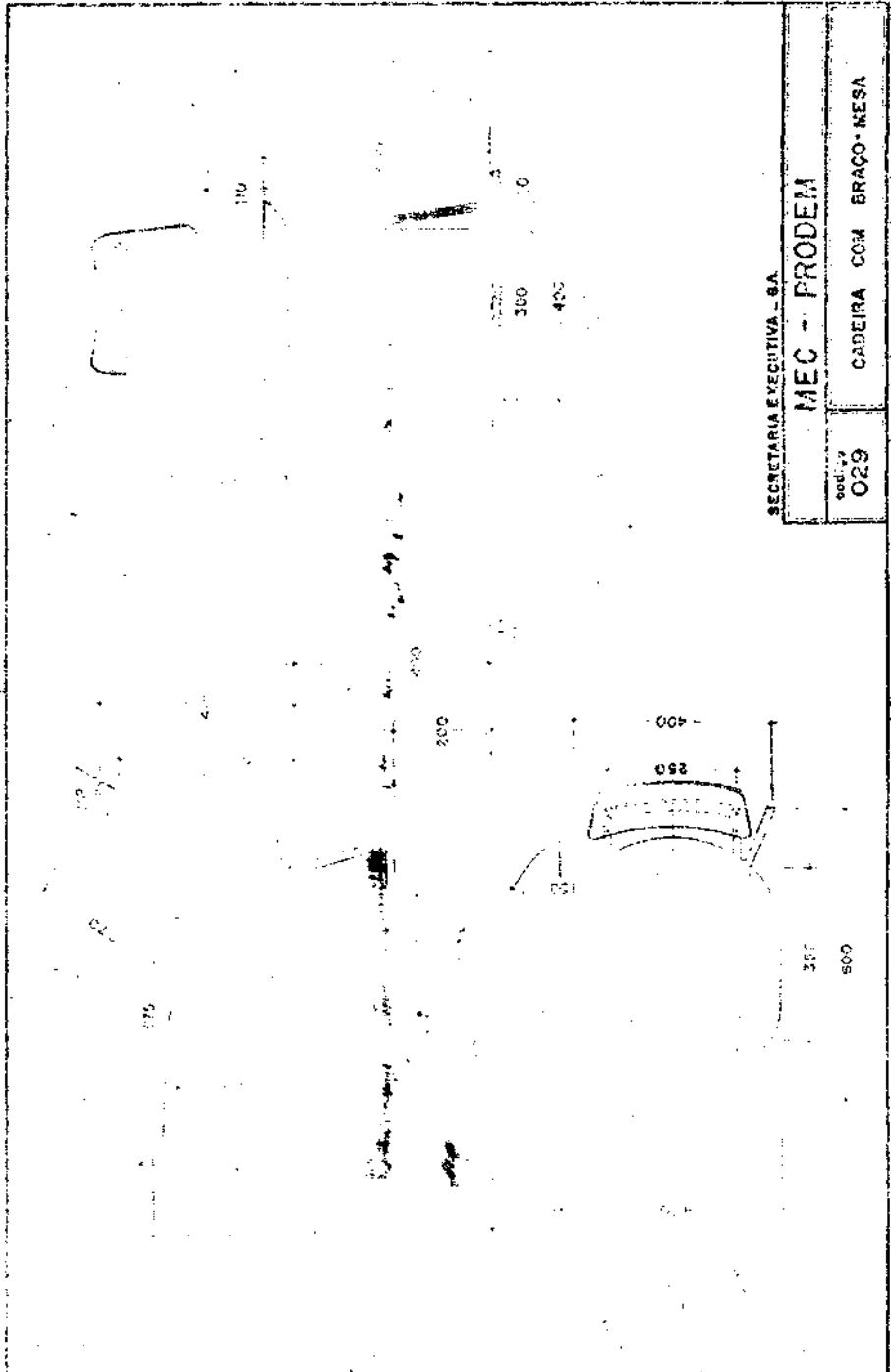

SECRETARIA EXECUTIVA - SA

MEC - PRODEM

CADEIRA COM BRACO-MESA

029

Junqueira

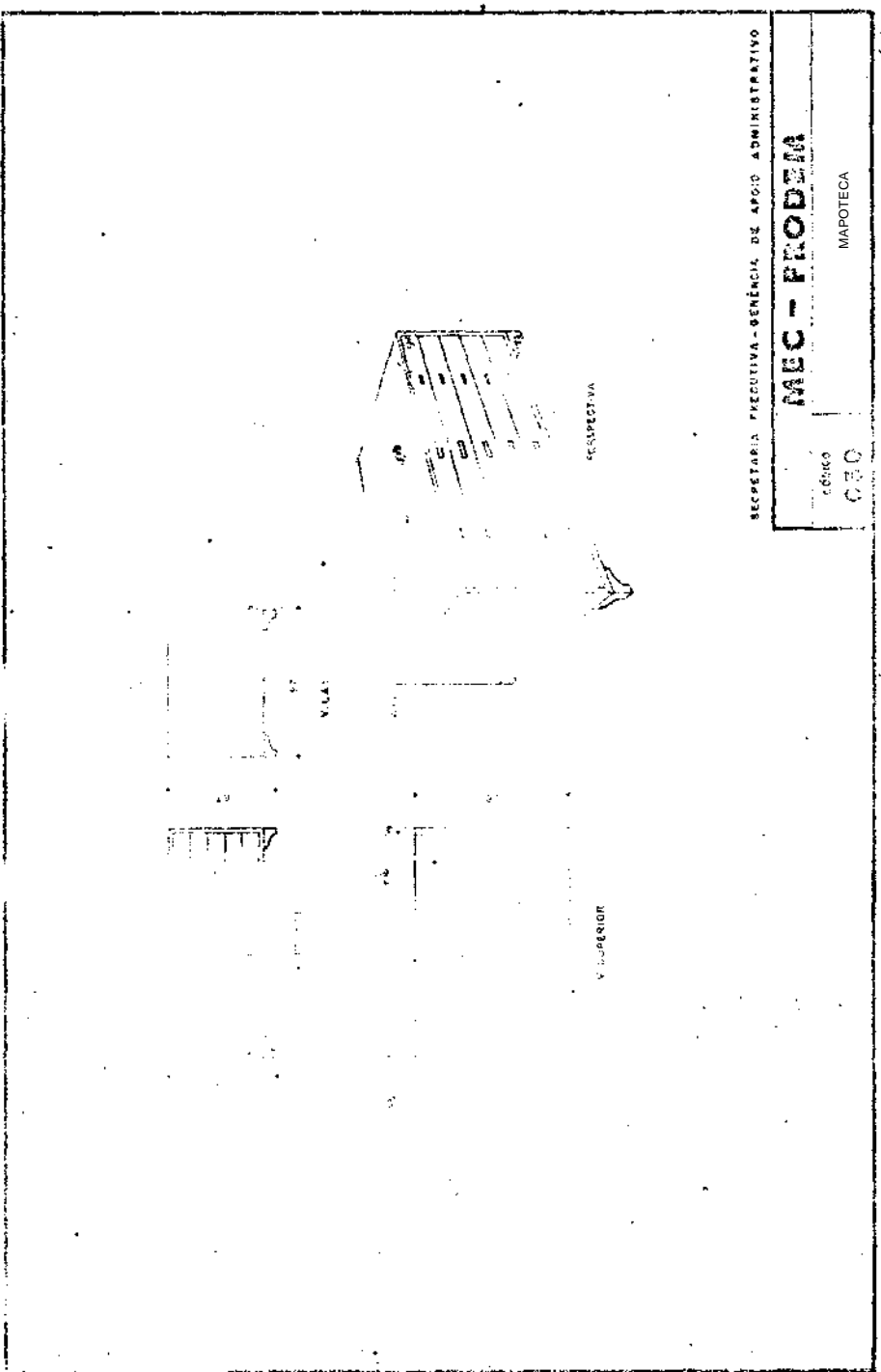

SECRETARIA PRECATORIA - GENÉRICA DE APOIO ADMINISTRATIVO

MEC - PRODEM

CÓDIGO
030

MAPOTECA

BRASIL

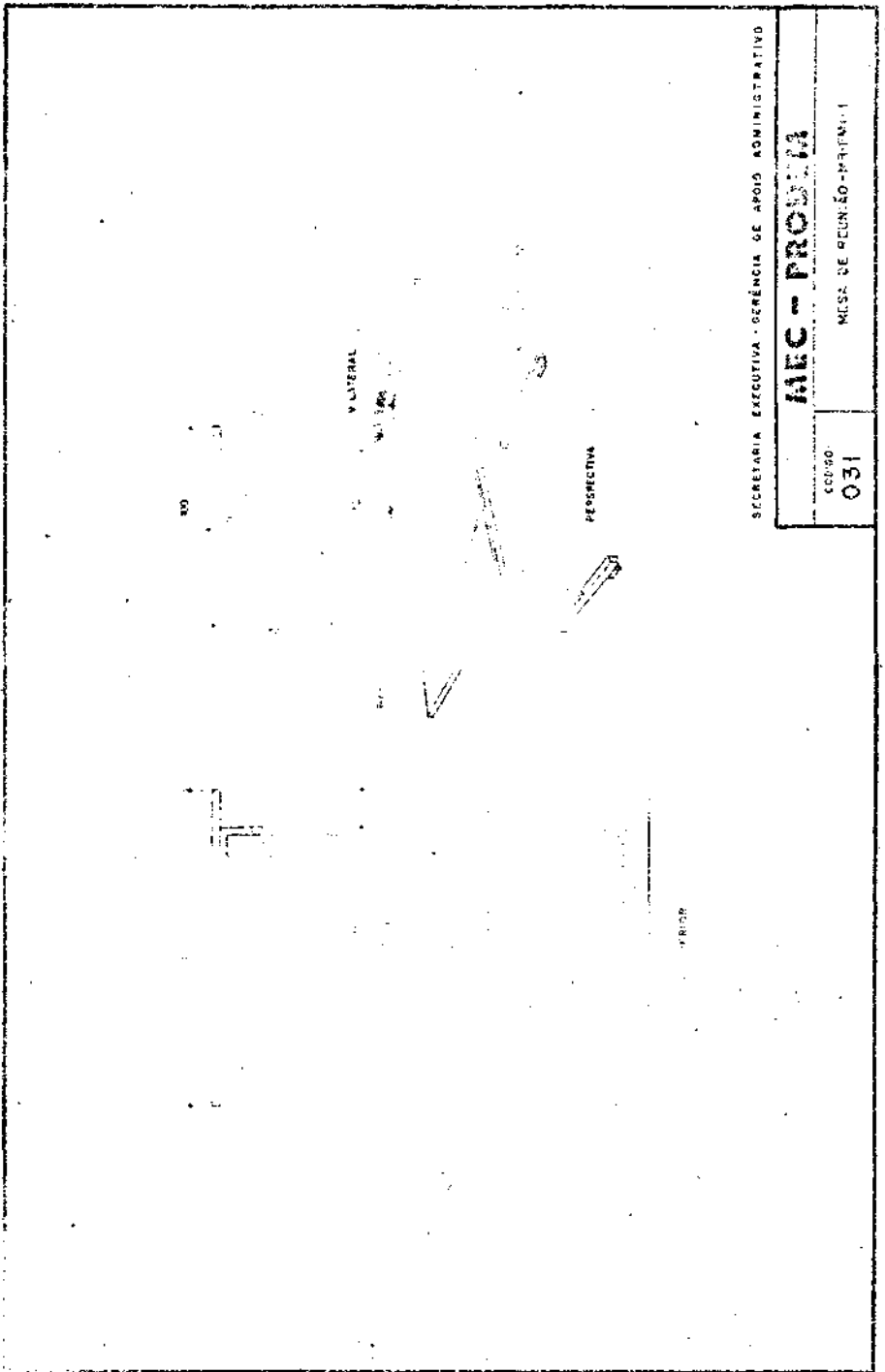

NO

V. LATERAL

UNIVERS

PERSPECTIVA

TERMINO

SECRETARIA EXECUTIVA - GERENCIA DE APOIO ADMINISTRATIVO

MEC - PROBLEMA

CODIGO

031

MESA DE TRABALHO - MATIN

19/07/77

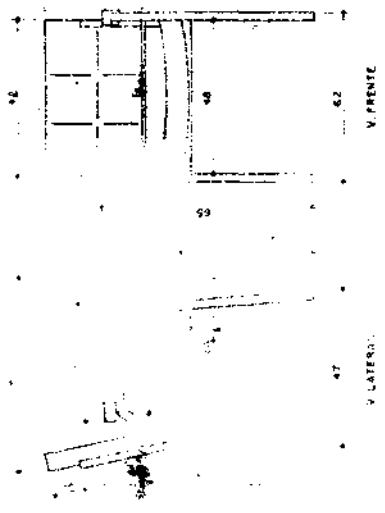
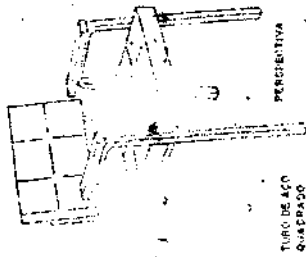

SECRETARIA EXECUTIVA - SEERÊNCIA DE APOIO ADMINISTRATIVO

MEC - PRODEM

POLTRONA FIXA C/ BRAÇO

EDIM: 032

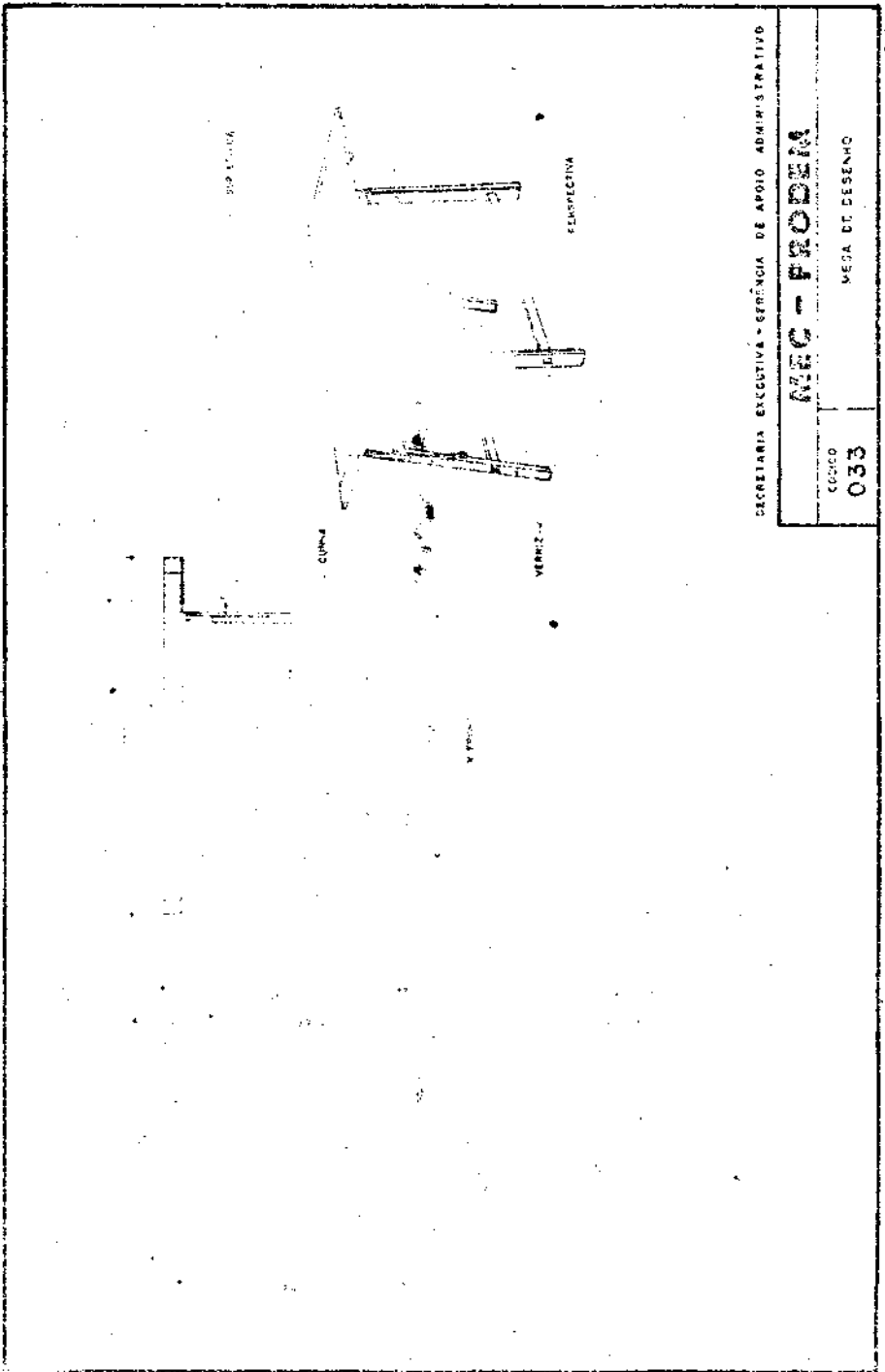

SECRETARIA EXECUTIVA - GERENCIA DE APOIO ADMINISTRATIVO

MEC - PRODEM	
CODIGO	MESA DE DESENHO
033	

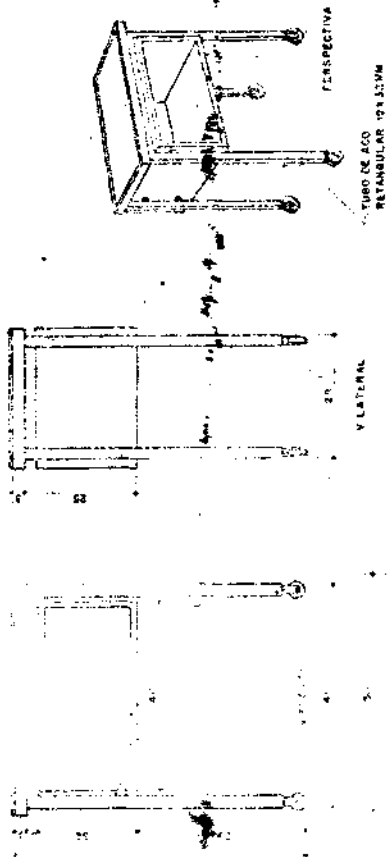

SECRETARIA EXECUTIVA - GEFINCA - DE APOIO ADMINISTRATIVO

MEC - PROJETO

MESA DE TELEFONE FMI-I

CÓDIGO:
034

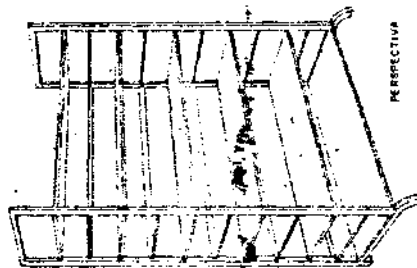

PERSPECTIVA



CORTE A-B

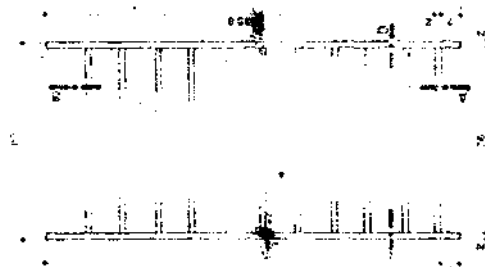

V.FRONT

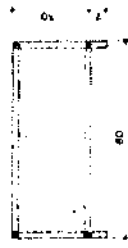

CORTE C-D

TUBO DE ACO
METALICULAR 10332 MM

SECRETARIA EXECUTIVA-GERENCIA DE APOIO ADMINISTRATIVO

MEC - PRODEM

CÓDIGO: 035
ESTANTE 17 BIBLIOTECA

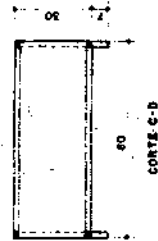
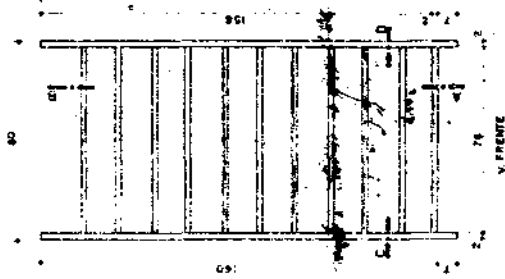
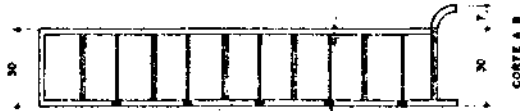
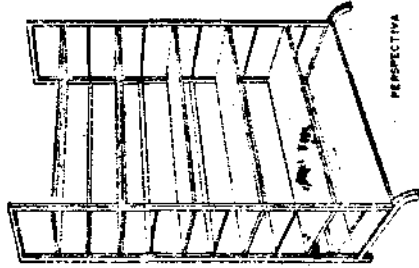

SECRETARIA EXECUTIVA - GERÊNCIA DE APOIO ADMINISTRATIVO

MEC - PRODEM

Código:
036

ESTANTE PARA LIVROS

84197

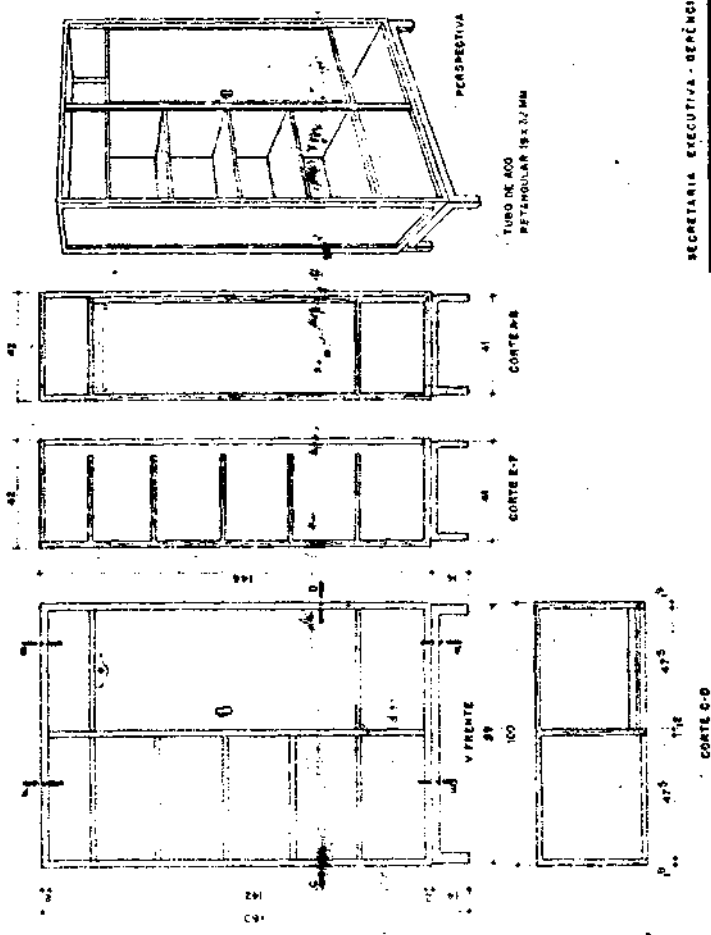

SECRETARIA EXECUTIVA - GENANCIA DE APOIO ADMINISTRATIVO

MEC - PRODEM

CODIGO **037**

ESTANTE PARA LIVROS E ROUPAS

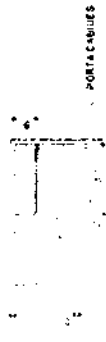

PORTACABINES



FRONT



RECALL
FRONT

80



PERSPECTIVE

VENEZIANA

LEPELMO

PORTA TOALHA

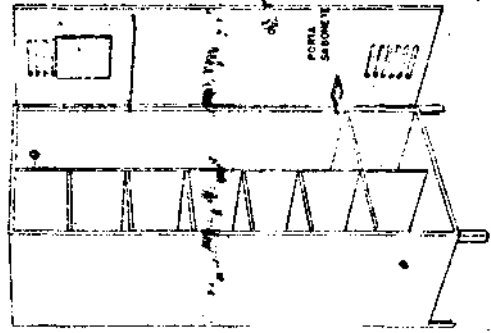

VENEZIANA

PERSPECTIVA

PORTA
SABONETE

SECRETARIA EXECUTIVA - GERÊNCIA DE APOIO ADMINISTRATIVO

AEC - PRODEM

CÓDIGO

038

ARMÁRIO DE AÇO
INTERMIO

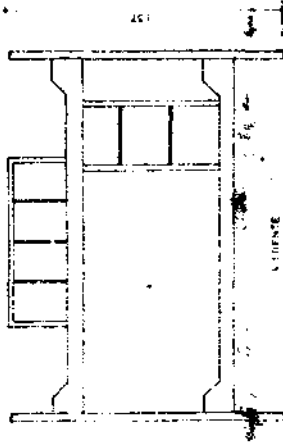

151

V. SUPERIOR

V. INFERIOR

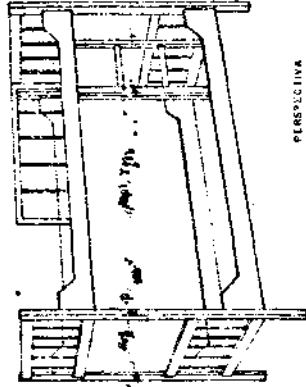

PERSPECTIVA

V. SUPERIOR

SECRETARIA EXECUTIVA - GERÊNCIA DE APOIO ADMINISTRATIVO

MEC - PRODEM

CODIGO

039

CAMA BELICHE

SECRET

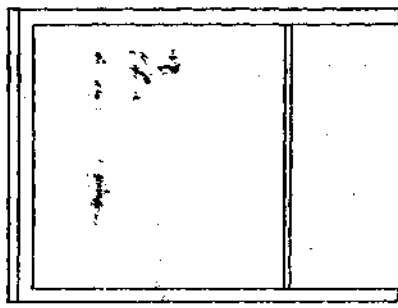
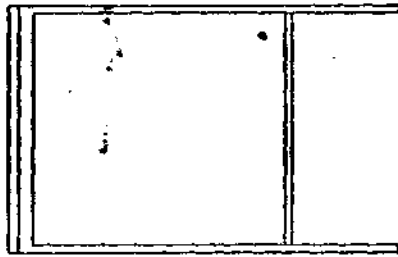
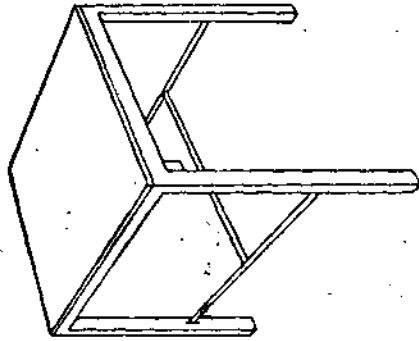

30118

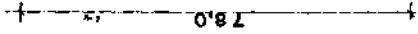

MEC-PRODEM	
CÓDIGO	MESA P/ MÁQUINA FOTOCOPIADORA
040	

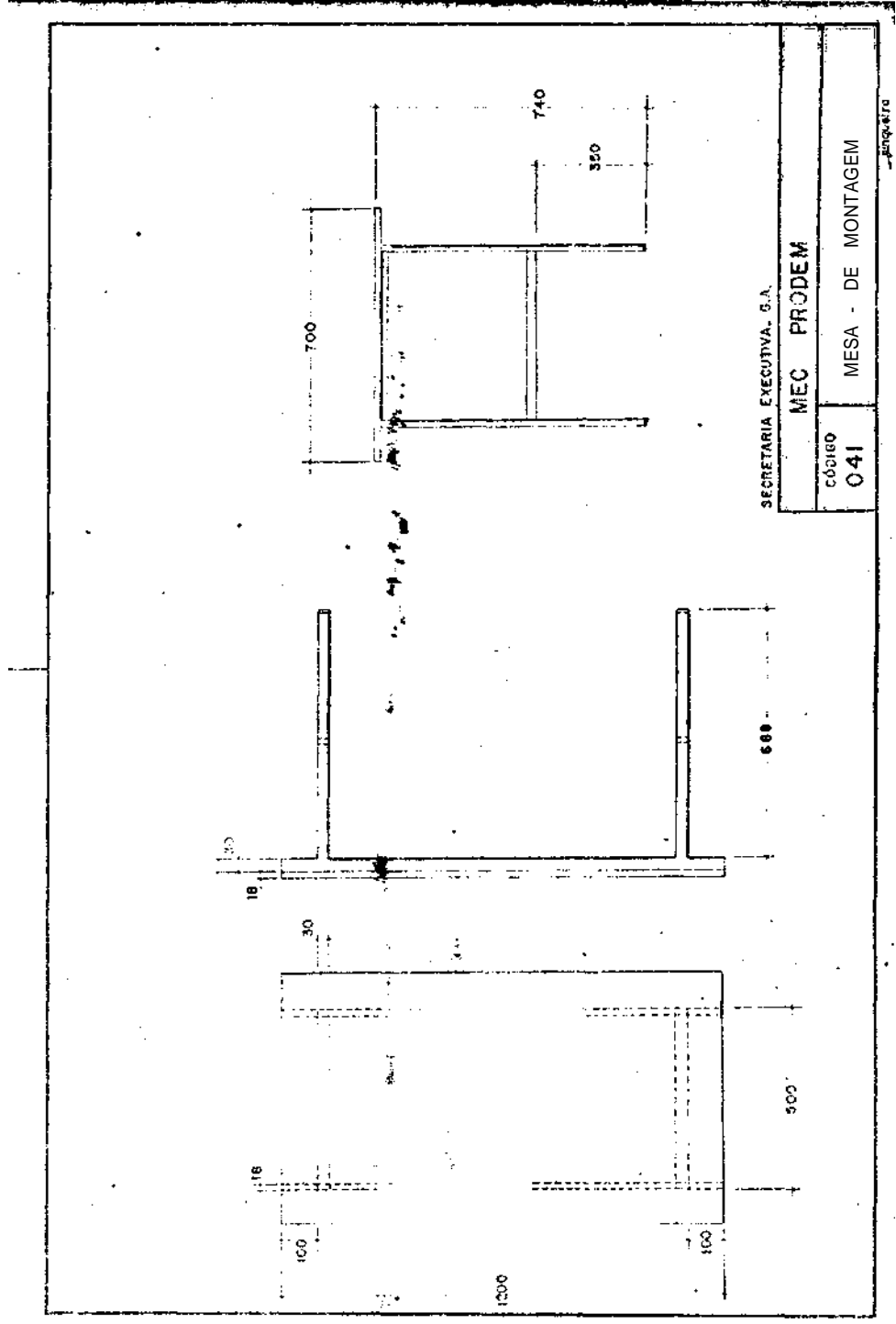

SECRETARIA EXECUTIVA. S.A.

MEC PRODEM

CÓDIGO

041

MESA - DE MONTAGEM

Projeto

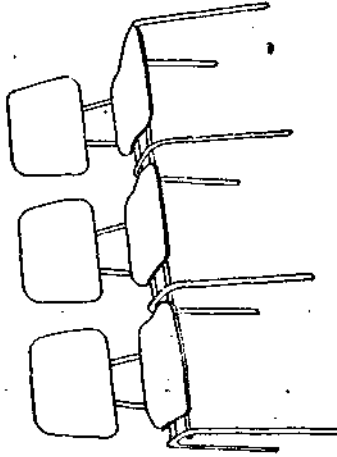
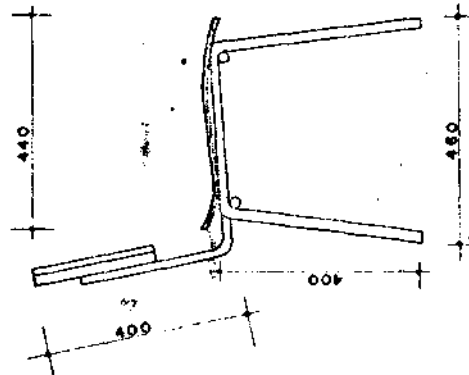
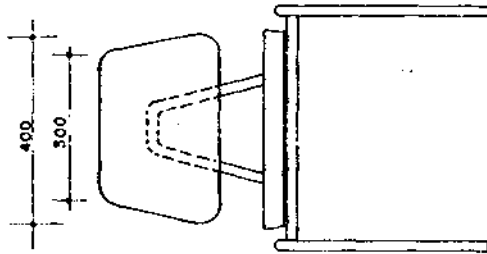

MEC - PRODEM

Código 042
CADEIRA PARA AUDITÓRIO

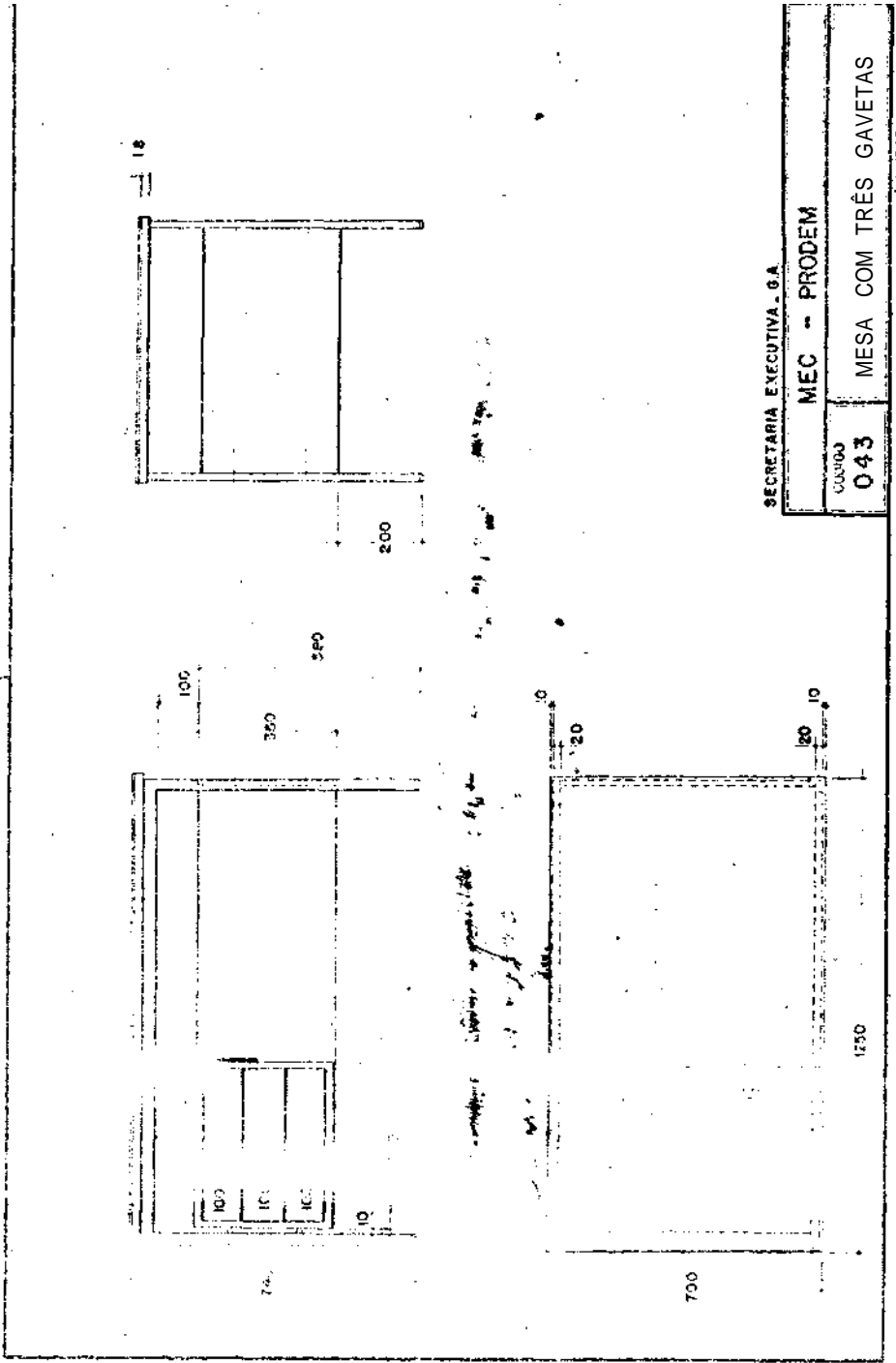

SECRETARIA EJECUTIVA - G.A.

MEC - PRODEM

CUSU00

043

MESA COM TRÉS GAVETAS

Unidade

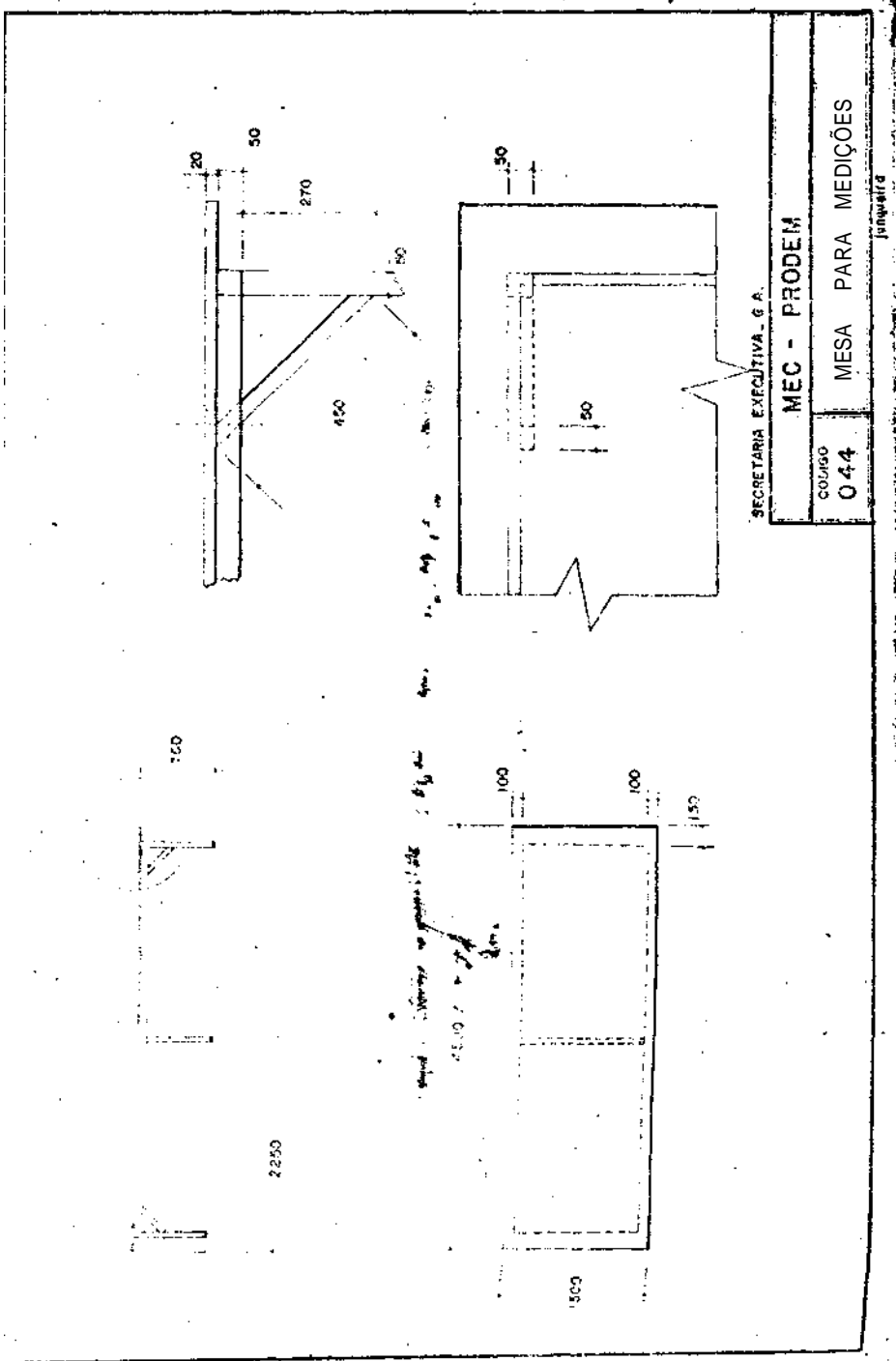

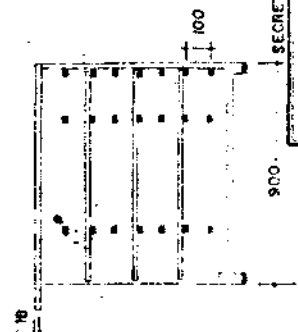
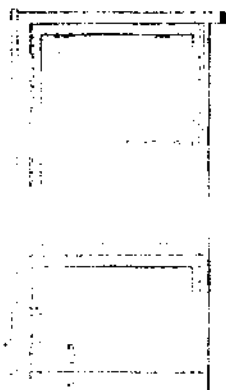
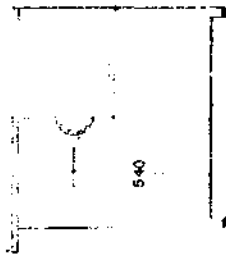
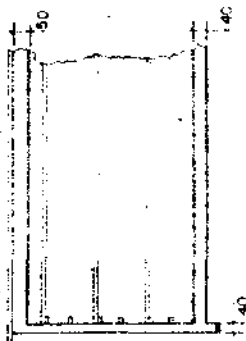
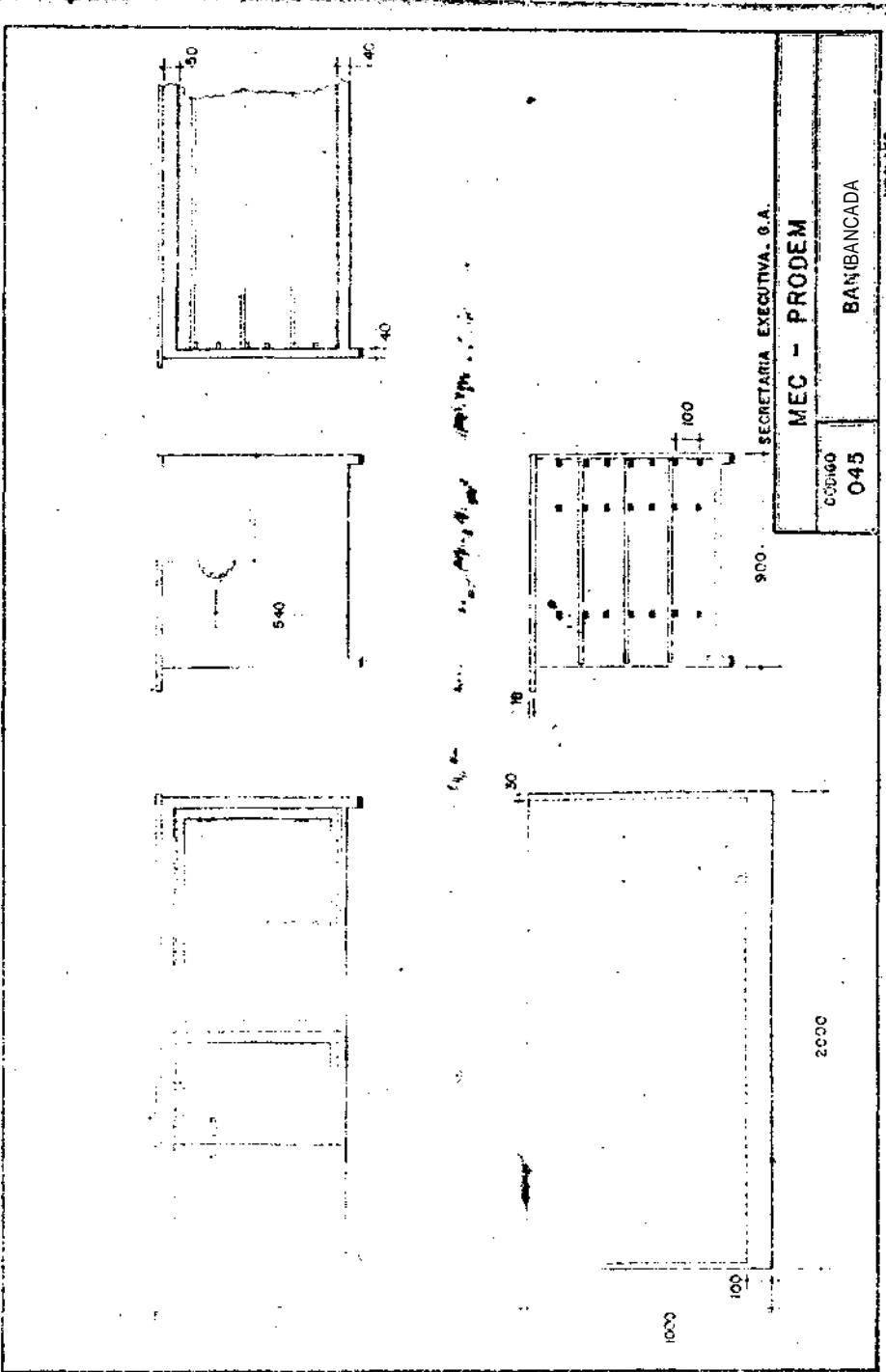

SECRETARIA EXECUTIVA. G.A.

MEC - PRODEM

000160

045

BANBANCADA

Jacques B

1000

100

2000

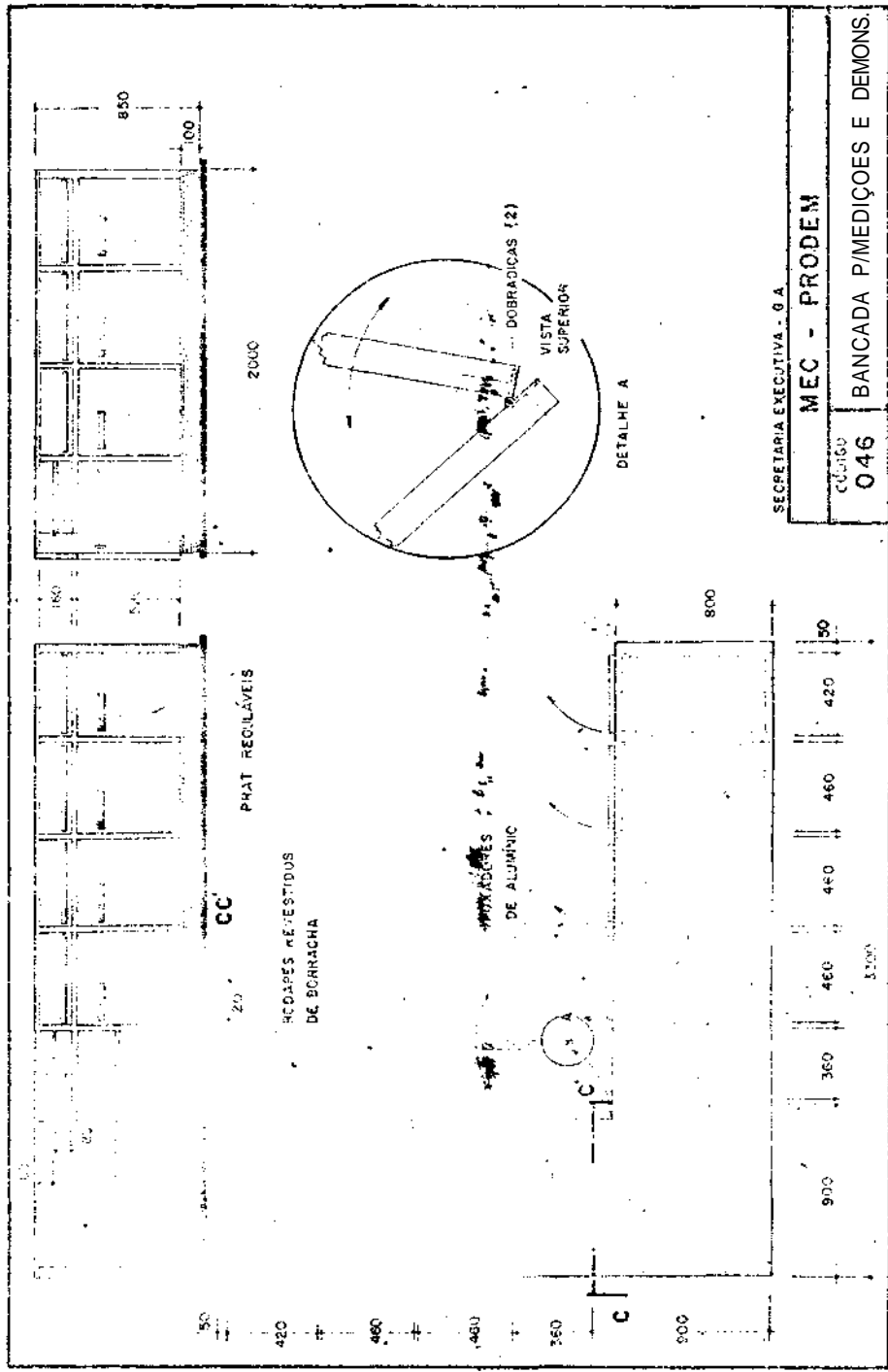

SECRETARIA EXECUTIVA - 9 A

MEC - PRODEM

CÓDIGO

046

BANCADA P/MEIÇÕES E DEMONS

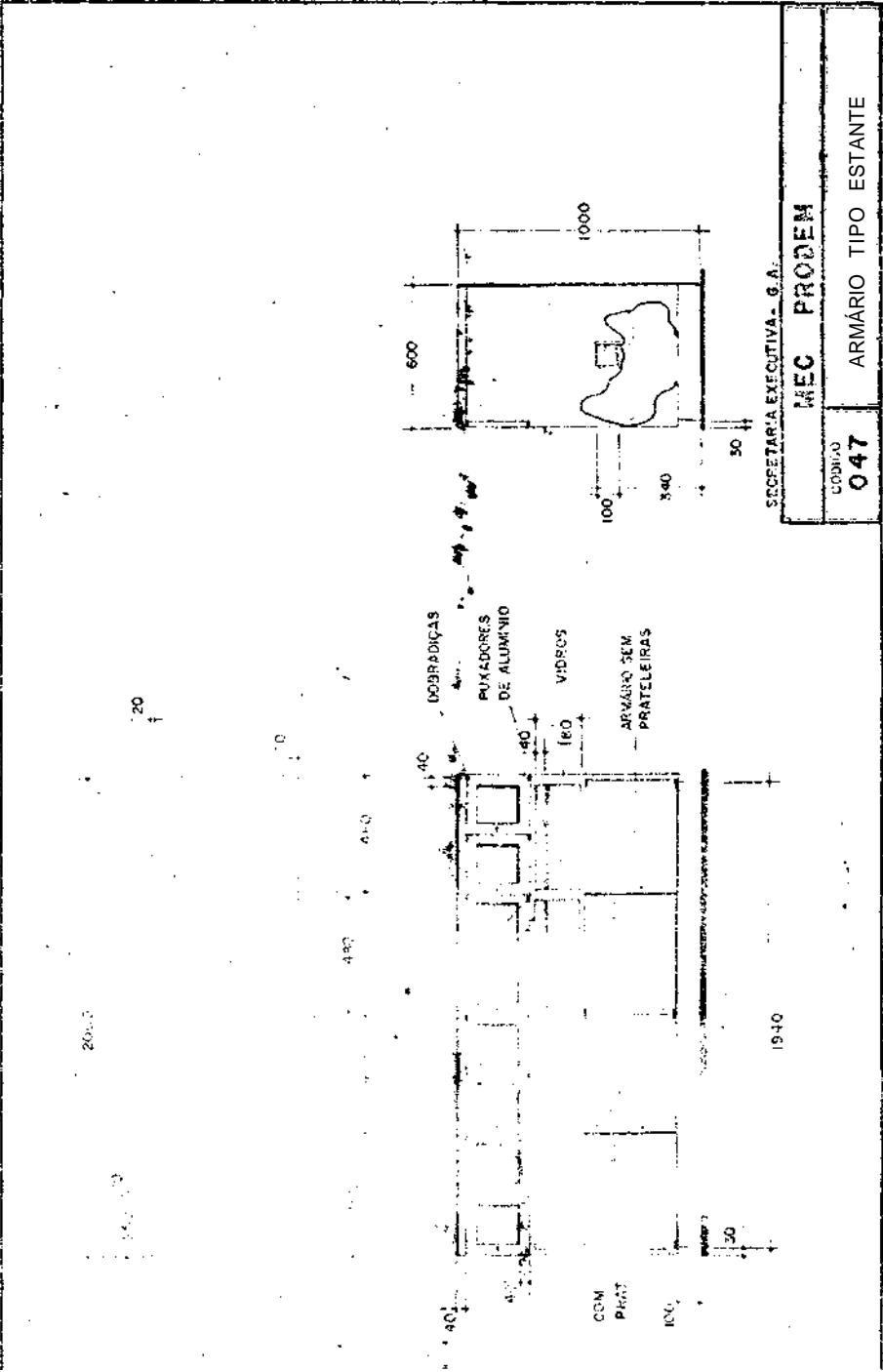

SECRETARIA EXECUTIVA - G. A.

MEC PROEM

CODIGO
047

ARMÁRIO TIPO ESTANTE

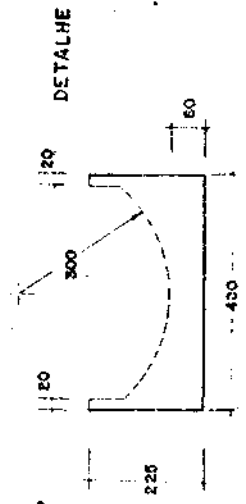
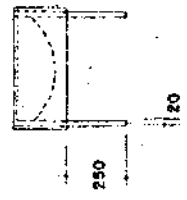
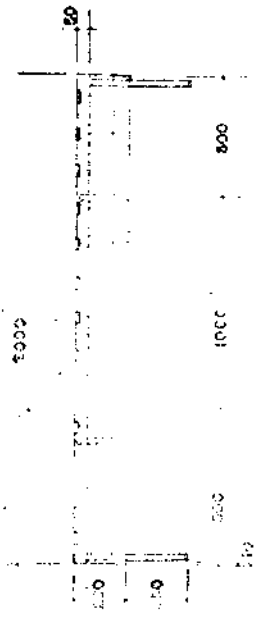

SECRETARIA EXECUTIVA S.A.

MEC - PRODEM

COLUNO
049

BANCO SEM ENCOSTO

Junqueira

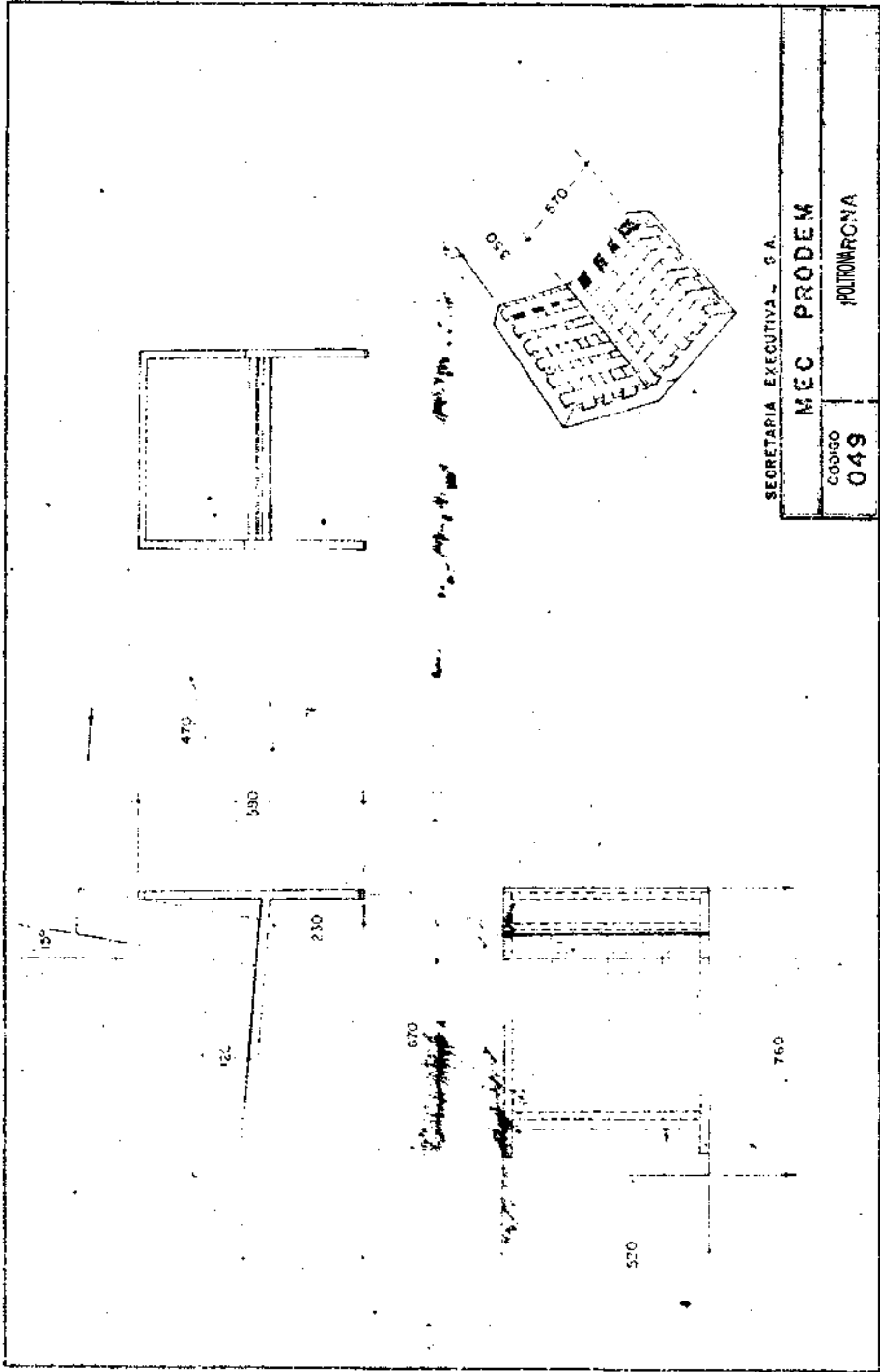

Jurquers

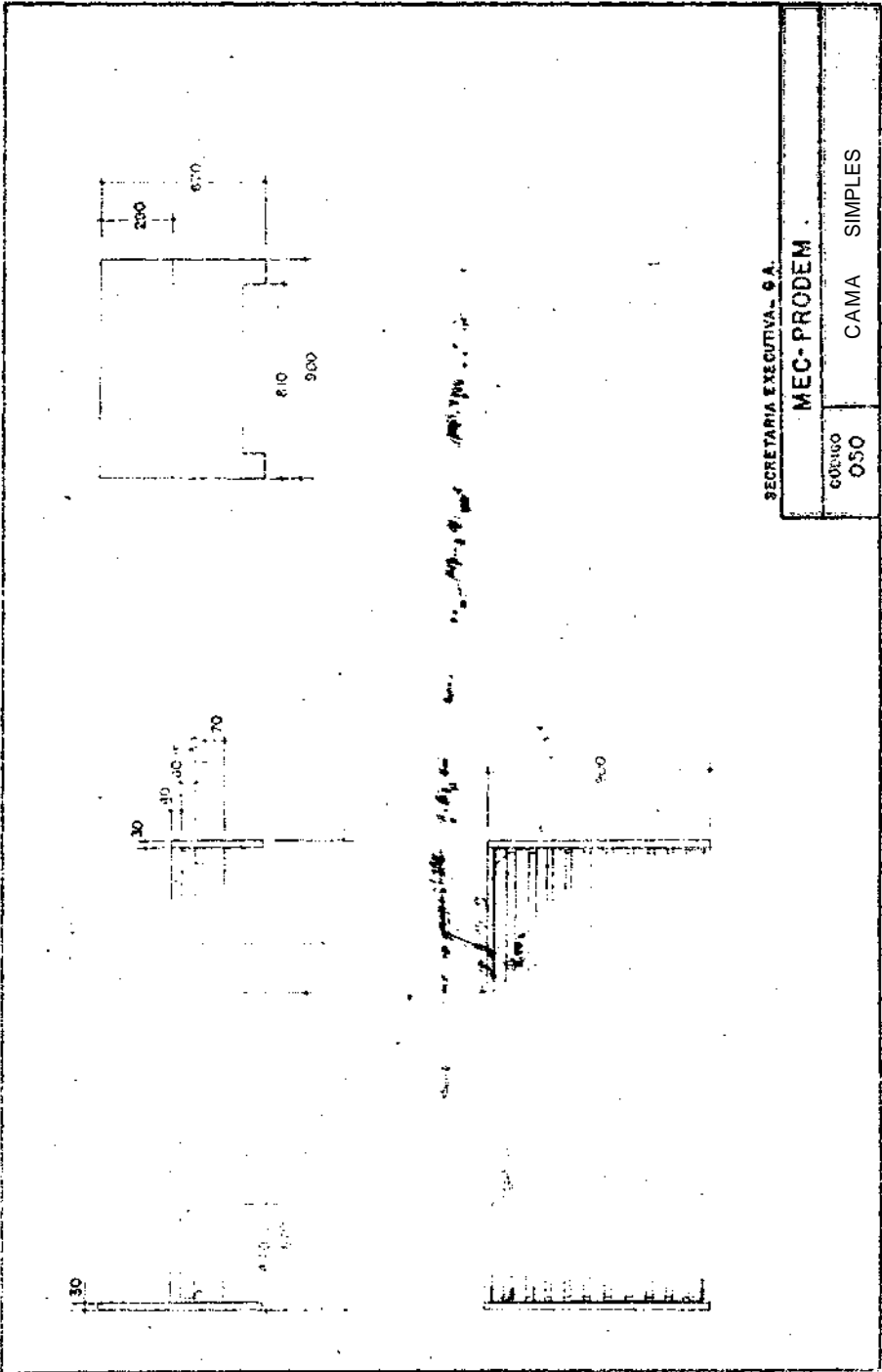

arquitecto

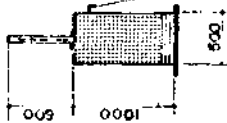
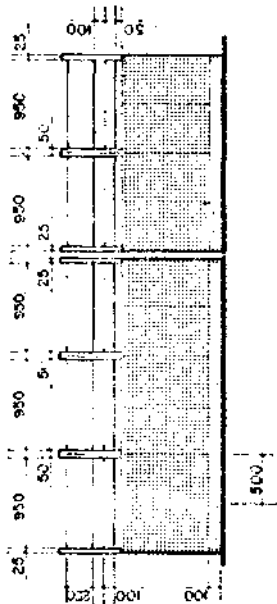

ESQUADRIAS DE ALUMÍNIO ANOZADO

PUXADORES DE ALUMÍNIO

RODAPÉ REVESTIDO EM BORRACHA

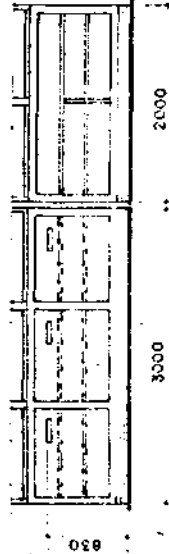

MEC_PRODUM

Código 051

BALCÃO DE RECEPÇÃO

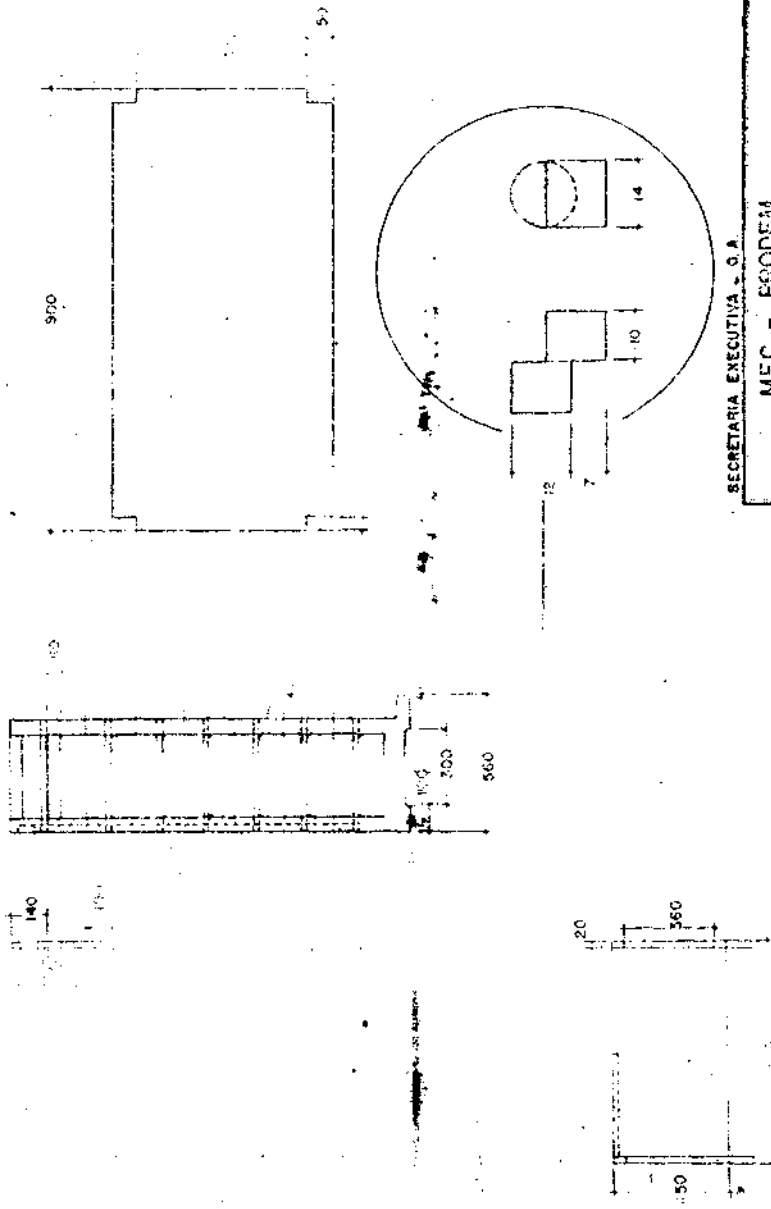

SECRETARIA EXECUTIVA S. O. A.
MEC - FRODEM
 CARGO **052** ESTANTE PARA PROFESSORES

1984/1985

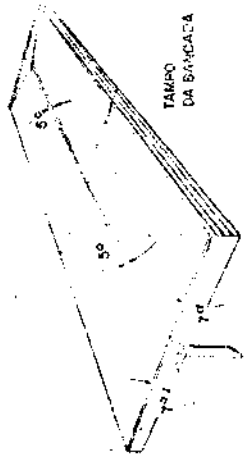

TAMPO DA BANCADA

REVESTIMENTO EM BORRACHA

TUBOS

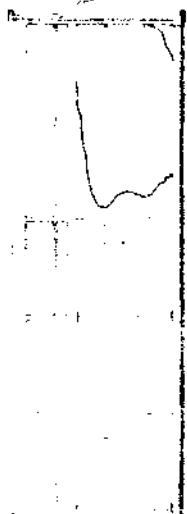
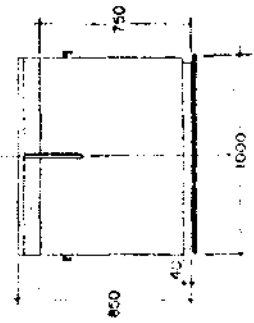

CANAL ETAS PARA O ESCUMENTO DA ÁGUA

SECRETARIA EXECUTIVA - P.A.

MEC PRODEM

650,00
063

BANCADA P/ LIXADEIRAS MECÂNICAS

Juliano

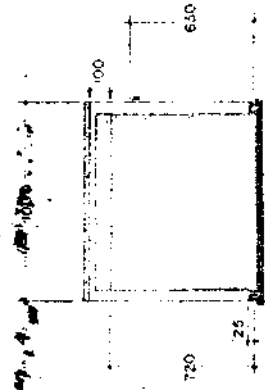
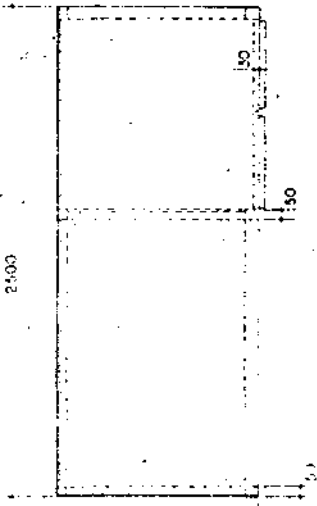

PUXADORES DE ALUMÍNIO

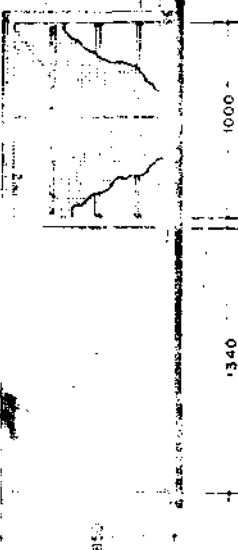

RODAPÉ REVESTIDO EM BORRACHA

SECRETARIA EXECUTIVA, S.A.

MEC - PRODEM

CODIGO 054

BANCADA PI LIXAD. MECÂNICA

PRODEM

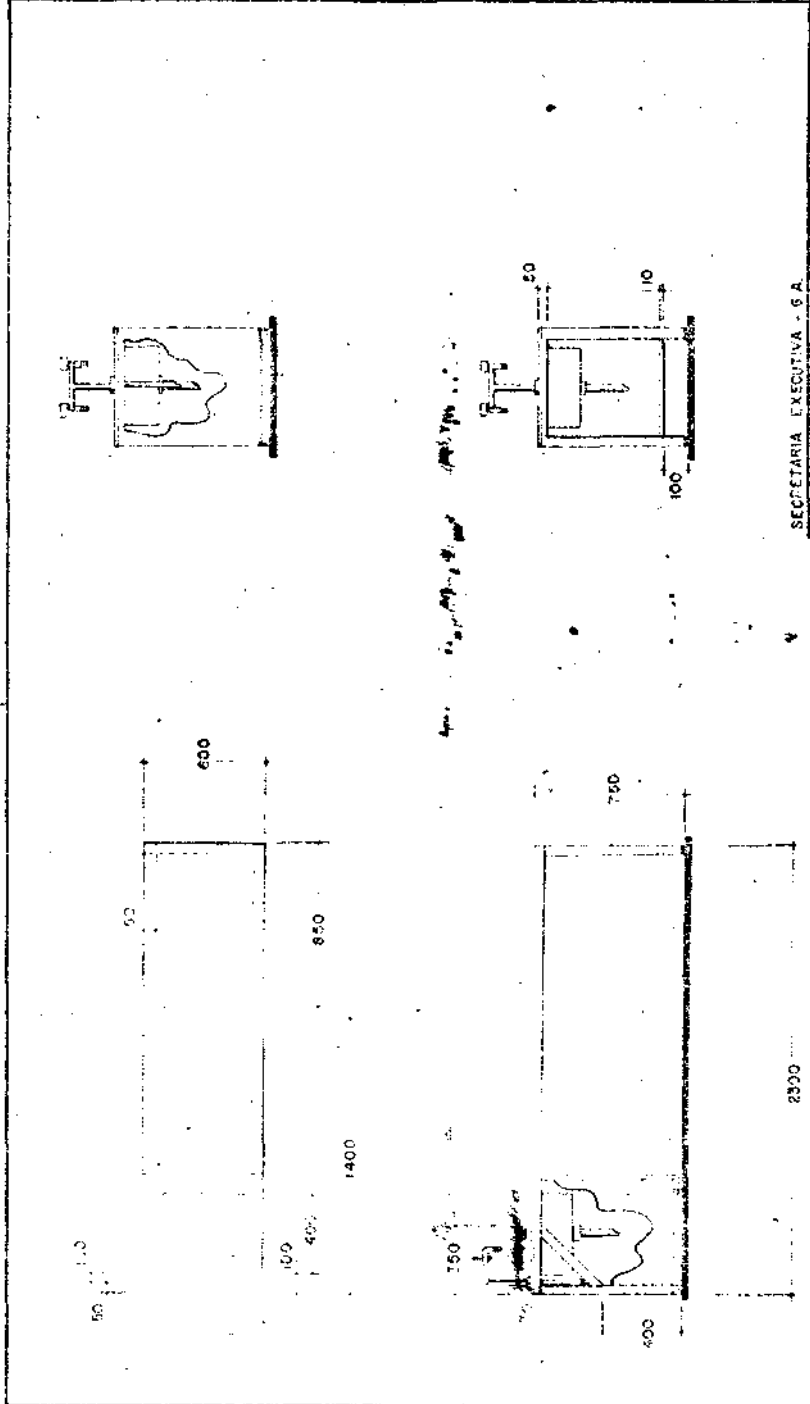

SECRETARIA EJECUTIVA - S.A.
MEC - PRODEM
 CONJUNTO
055
 BANCABANCA P/POLTRIZES MOTOR

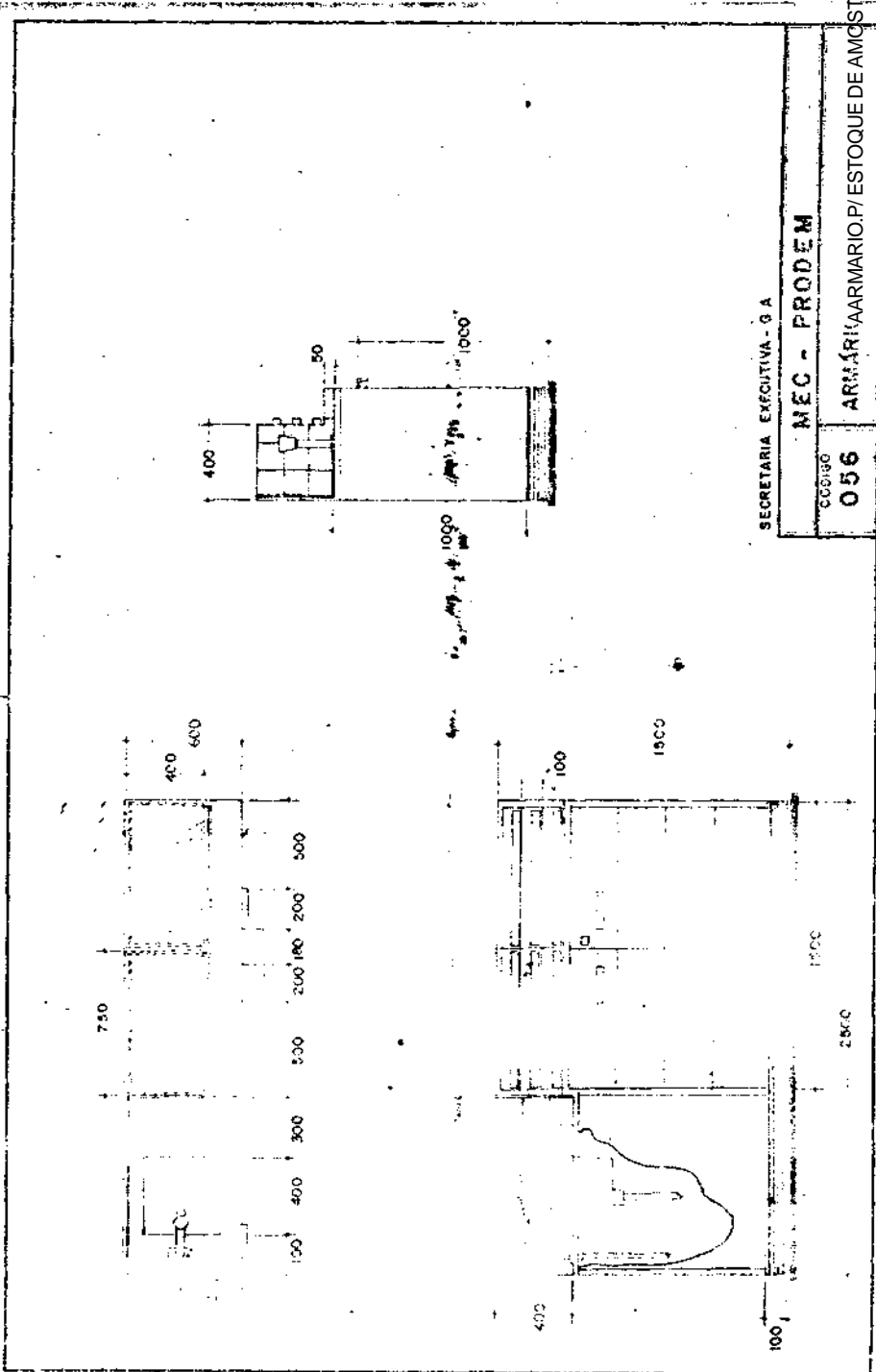

SECRETARIA EJECUTIVA - G A

NEC - PRODEM

000190
056

ARMARIO / ESTOQUE DE AMOSTRAS

Juequesano

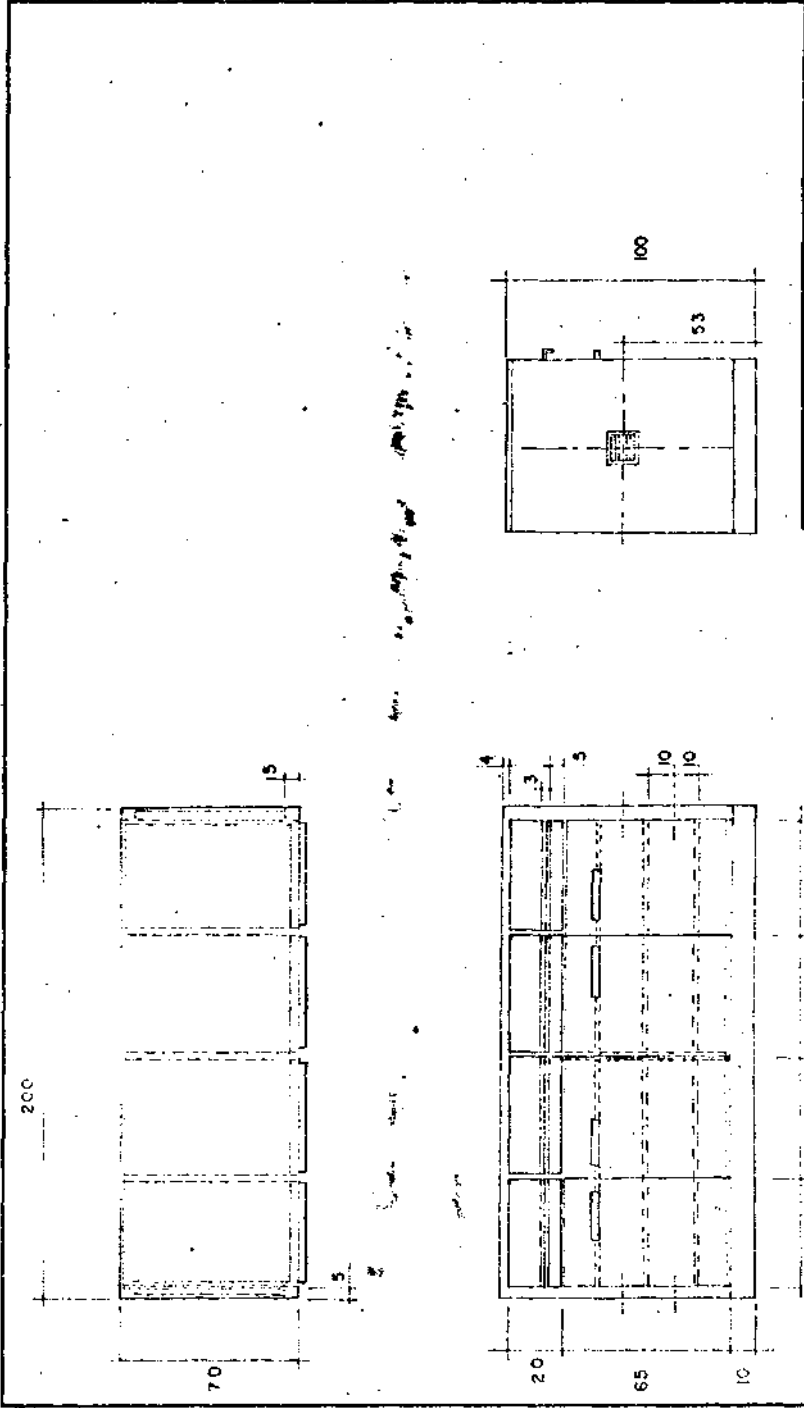

MEC PRODEM	
Código	057
ARMÁRIO P/ GUARDAR MICROSC.	

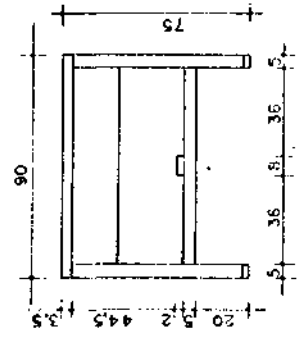
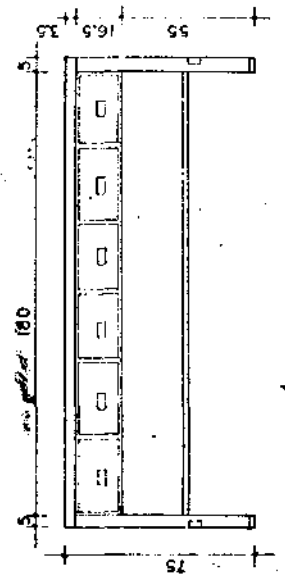
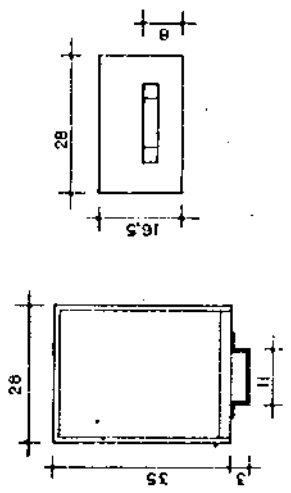
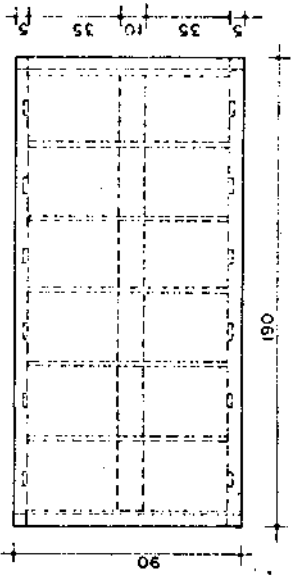

MEC - PRODEM	
CODIGO	058
MESA P/ COLOC.BAN.METALOGRAFICO	

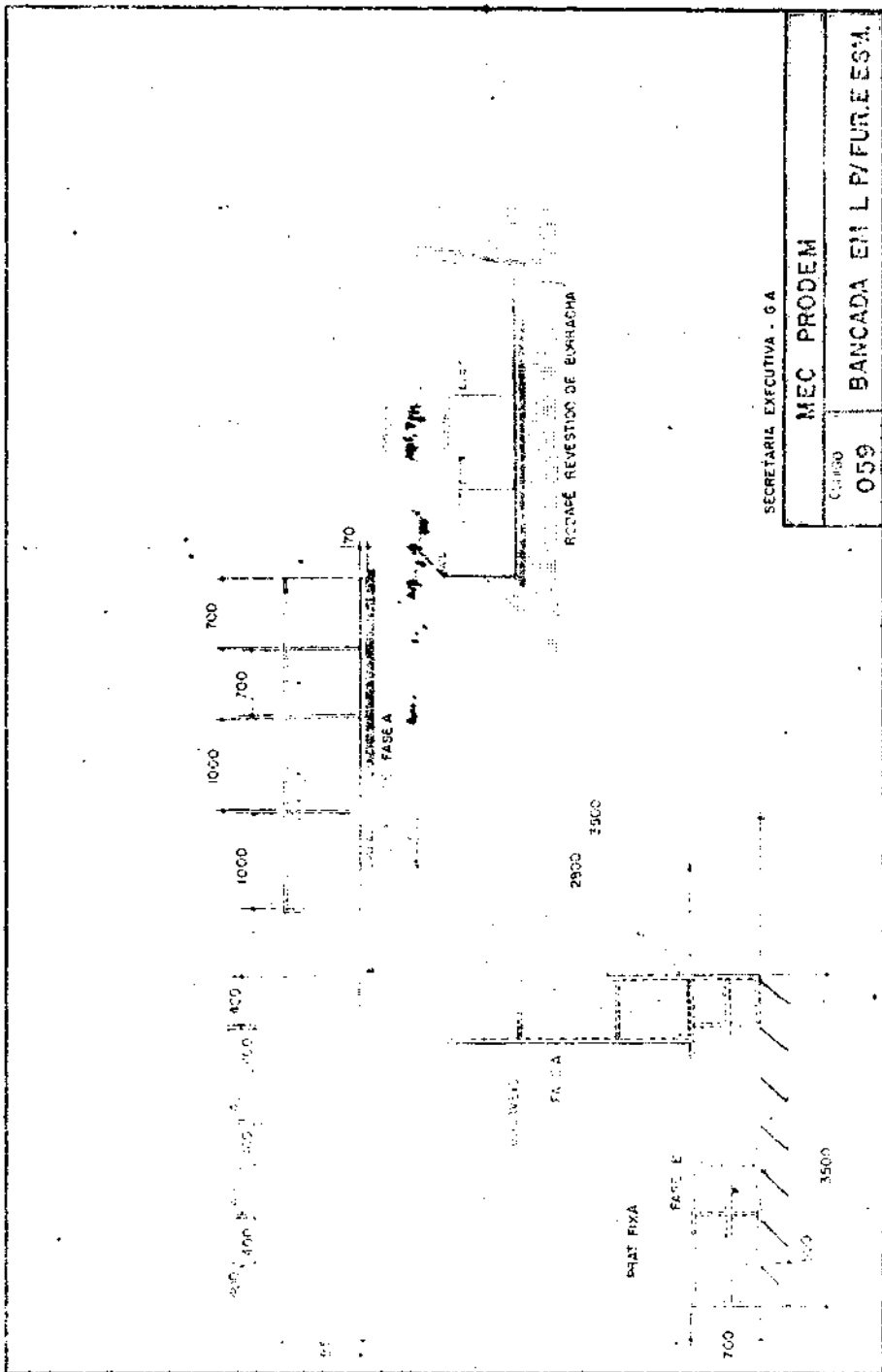

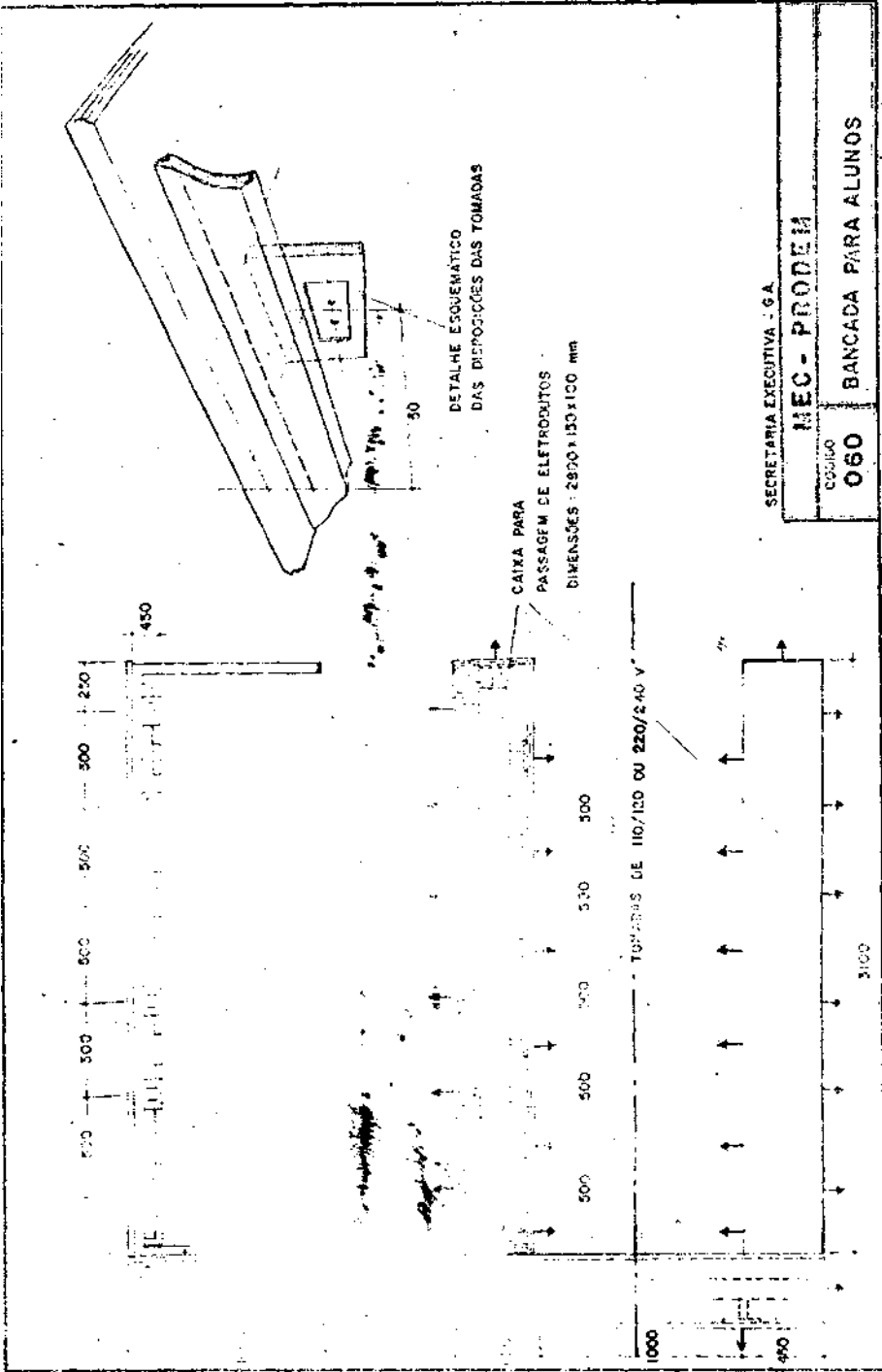

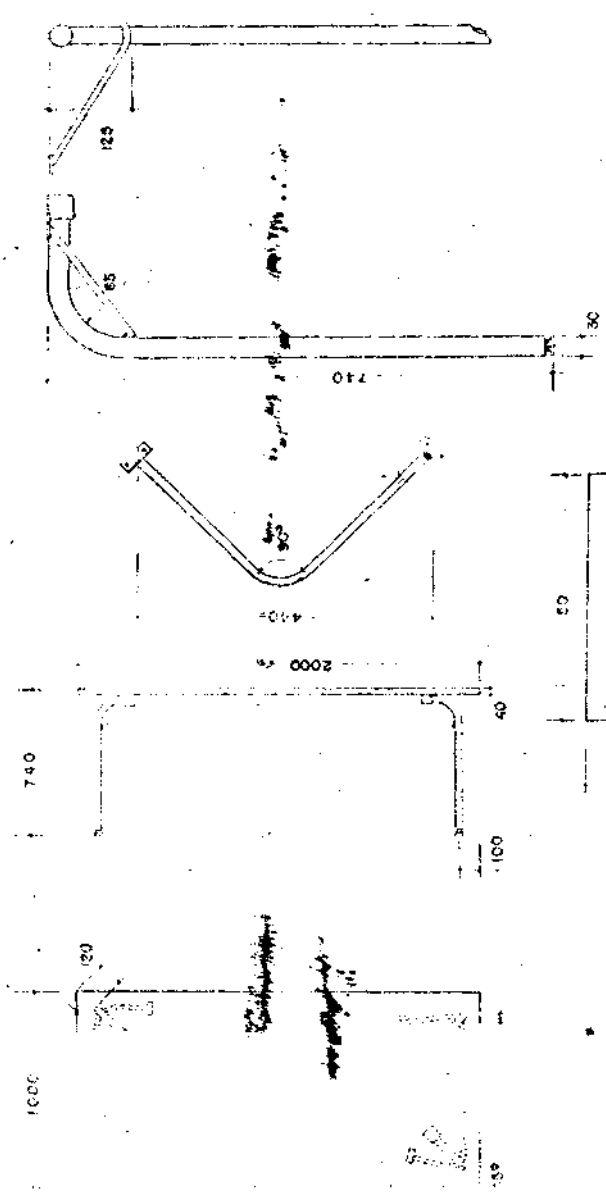

SECRETARIA EXECUTIVA - SA

MEC PRODEM

COP163

062

MESMESA PARA REFEITÓRIO

Arquiteto

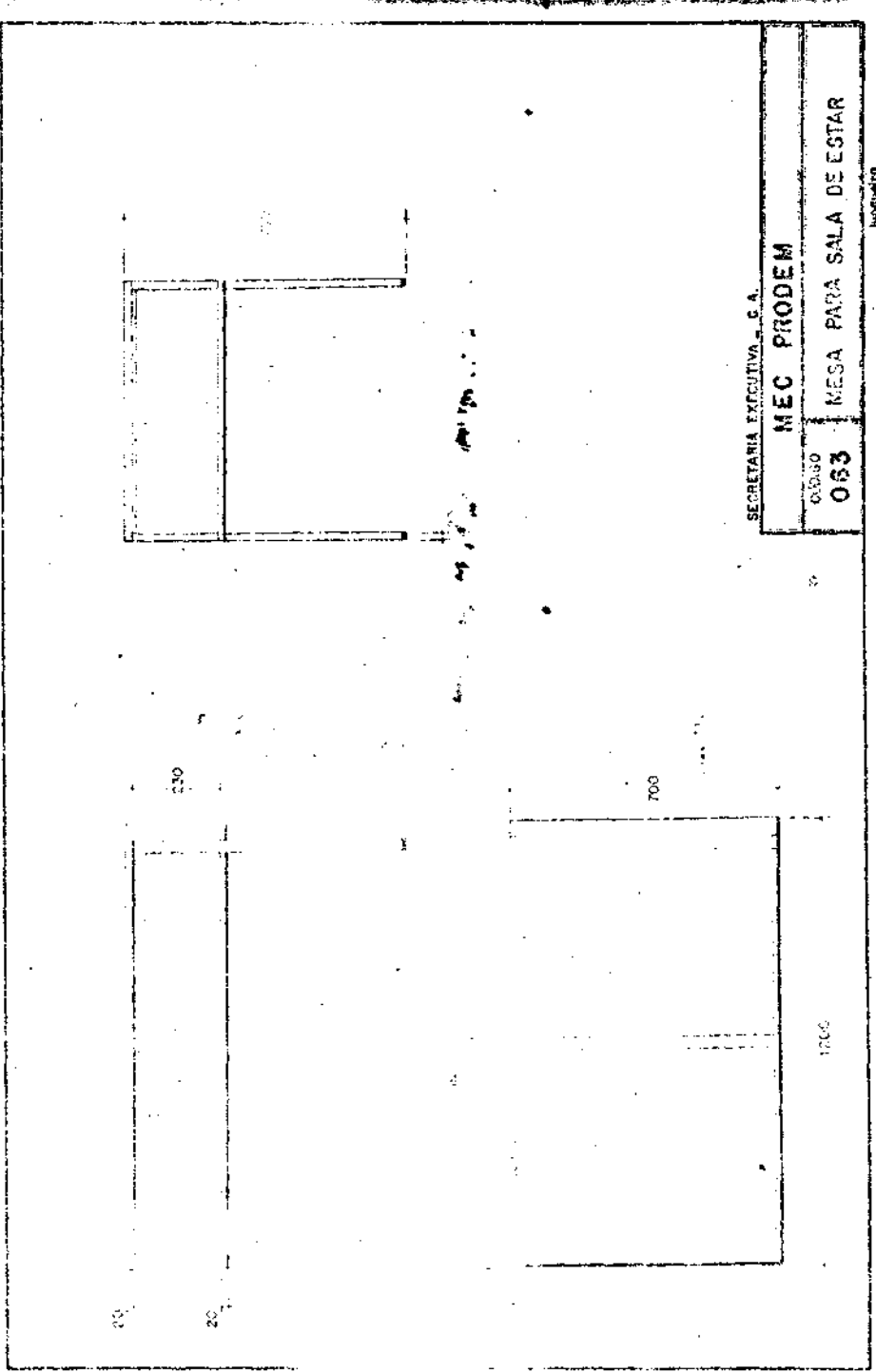

SECRETARIA EJECUTIVA S.A.

MEC PRODEM

03/03/00

063

MESA PARA SALA DE ESTAR

Jurqueito

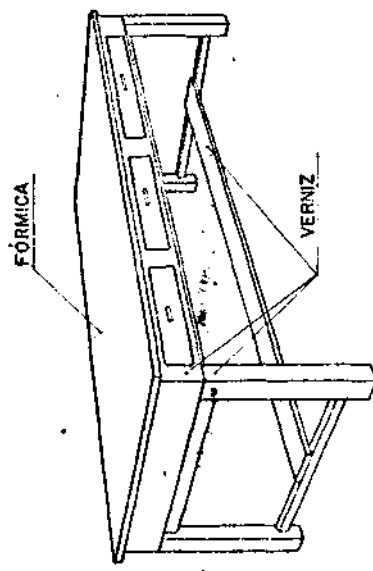
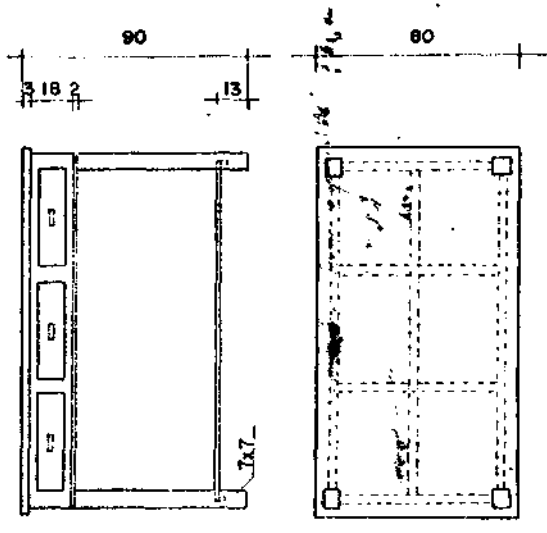

MEC - PRODEM	
CÓDIGO	BANCADA P/ ALUNOS
064	

D.R.

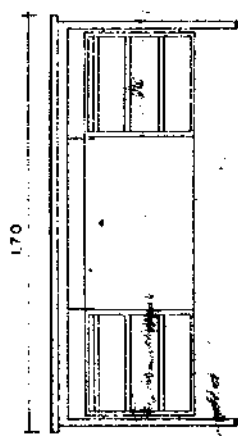
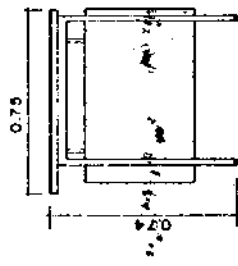

ESC 1:20

MEC PRODEM	
COD	MESA p/ GABINETE
065	

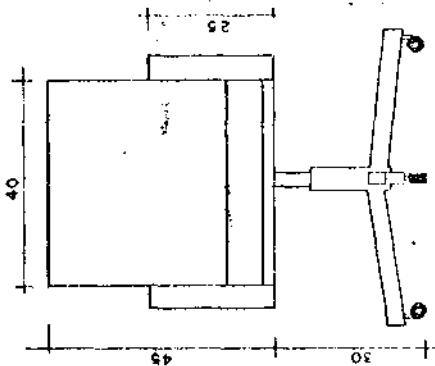
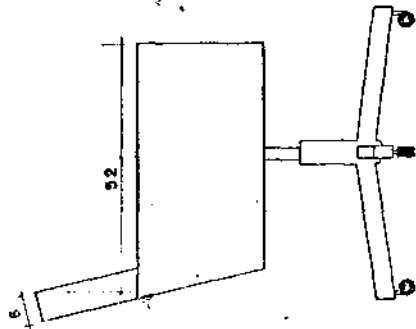
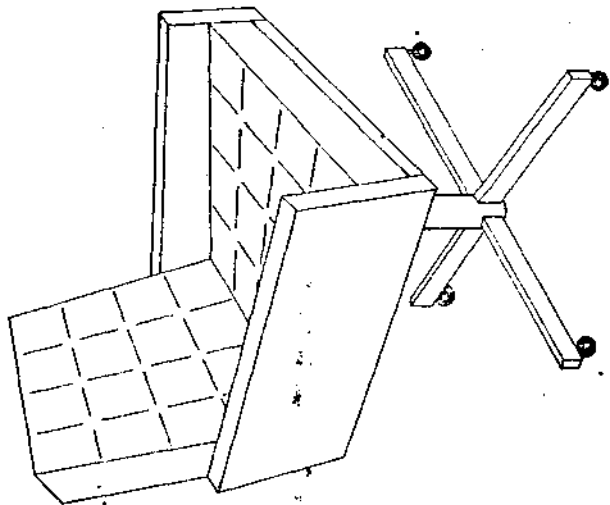

MEC PRODEM

504

066

CADEIRA DE GABINETE

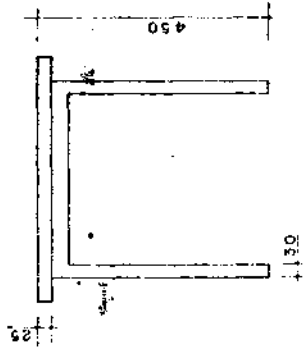
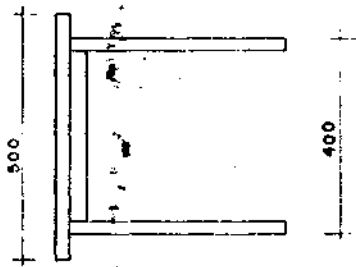

MEC PRODEM

067

MESA DE CANTO

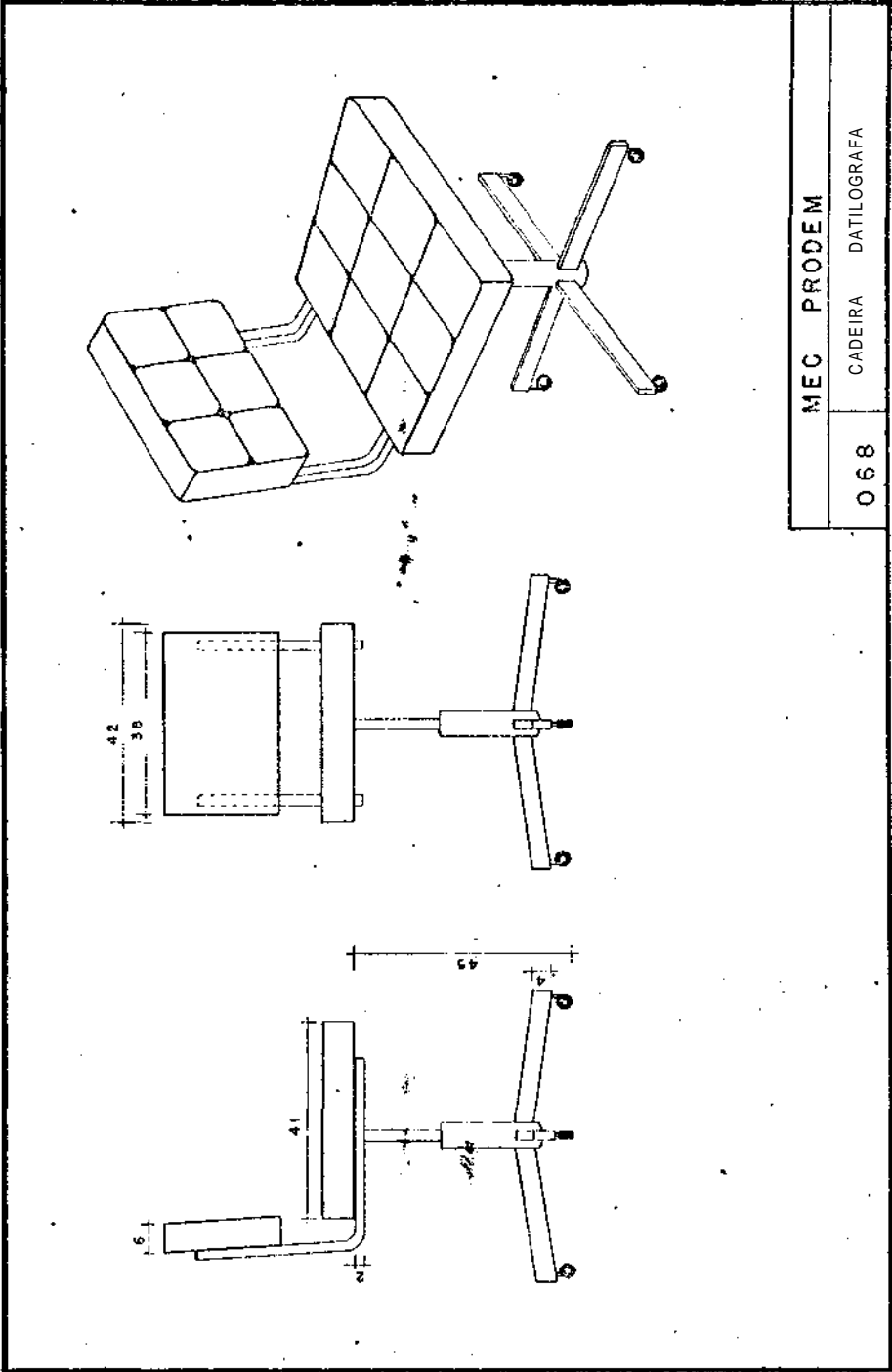

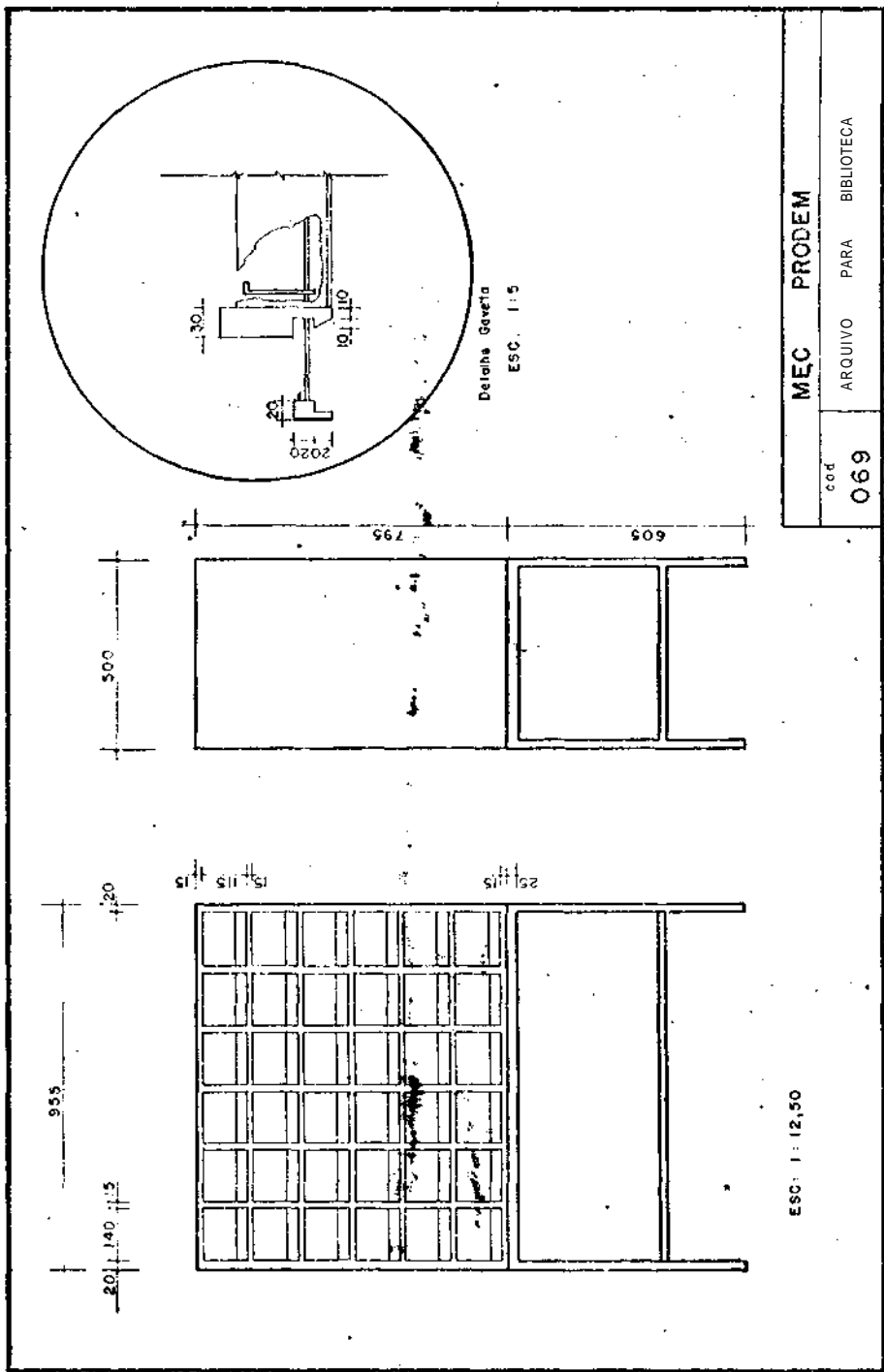

ESC: 1:12,50

MEC PRODEM	
cod	069
ARQUIVO	PARA BIBLIOTECA

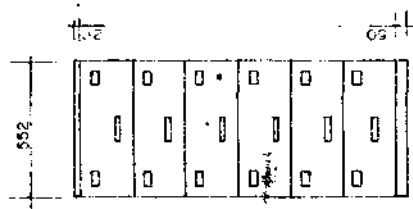
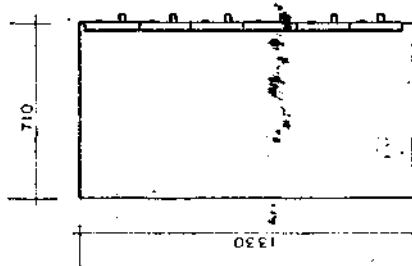

MEC PRODEM

FICHÁRIO DE AÇO

070

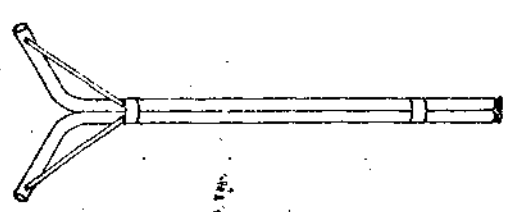
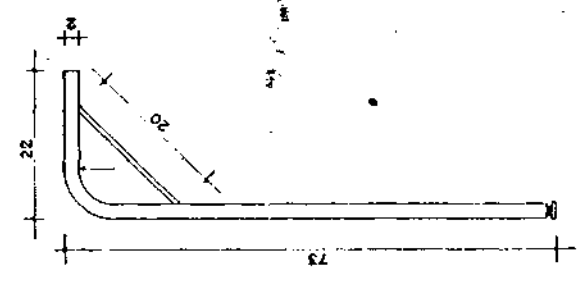
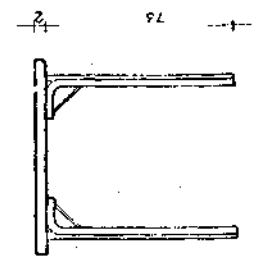
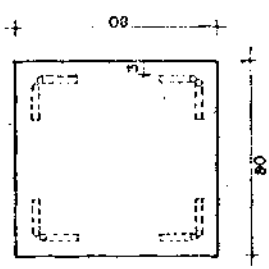

MEC		PRODEM	
CCO	071	MESA	PARÁ CANTINA

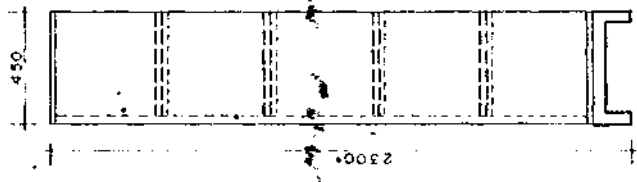
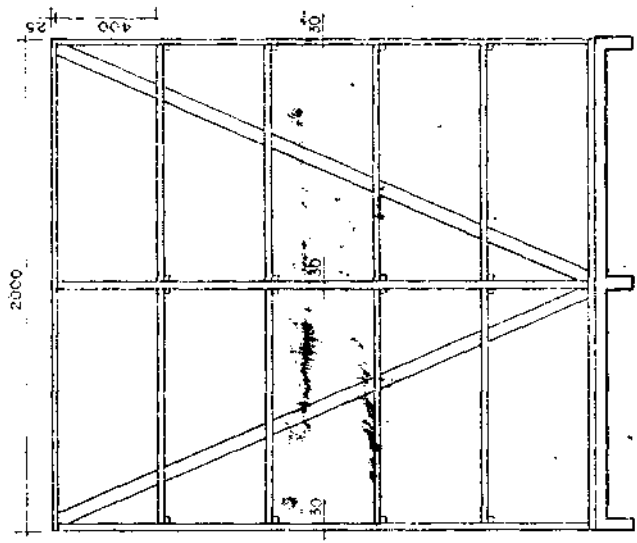

MEC PRODEM

CONJUNTO PRATELEIRAS p/ ROUPARIA

072

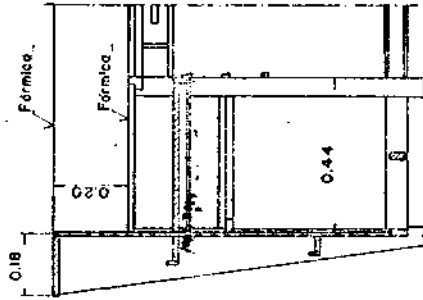
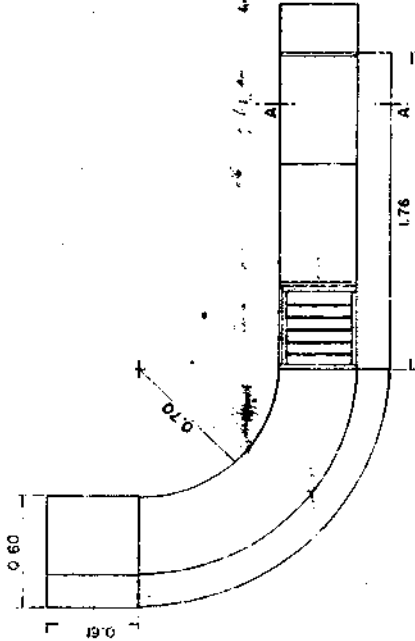
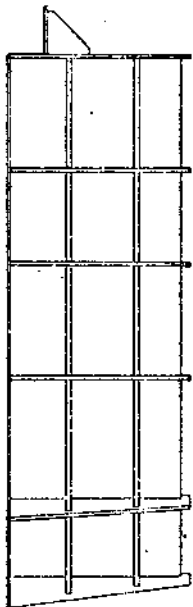
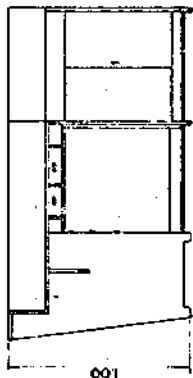

CORTE A-A

MEC - PRODEM	
CÓDIGO	BALÇÃO DE EMPRÉSTIMOS
073	

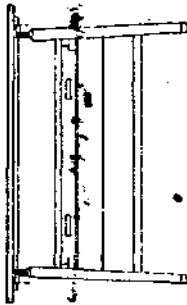
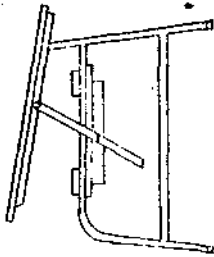
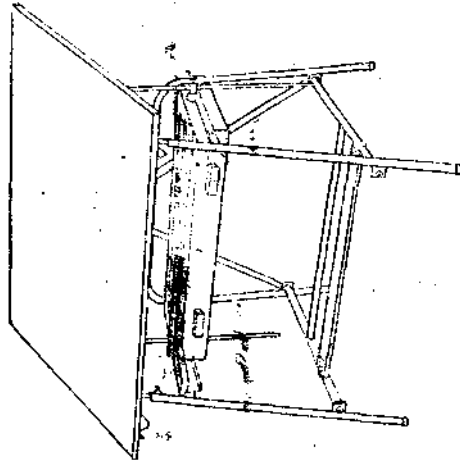

MEC - PRODEM

PRANCHETA PARA DESENHO

CÓDIGO
074

DR

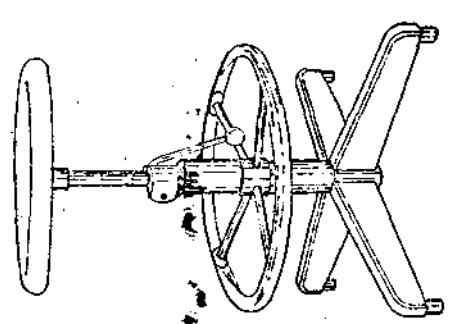
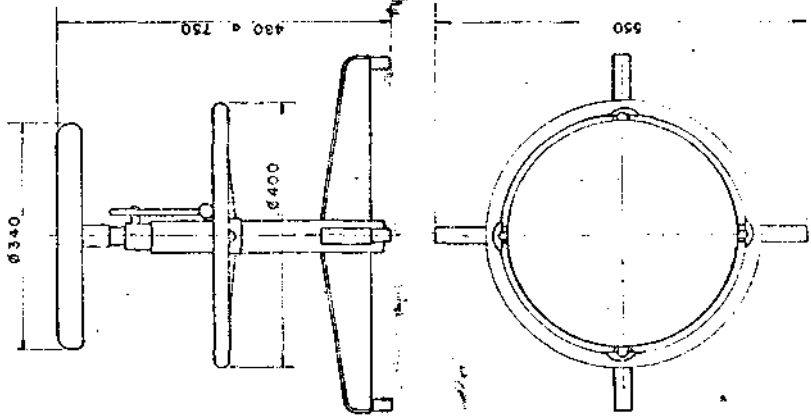

MEC - PRODEM	
075	BANCO PARA DESENHO

100 + 325 + 100

200 170

360 100

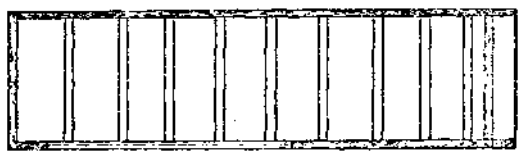
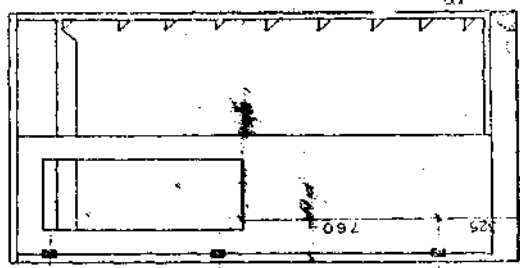

1100



MEC - PRODEM	
CÓDIGO	ARMÁRIO PARA MATERIAL
C 7 6	

DR

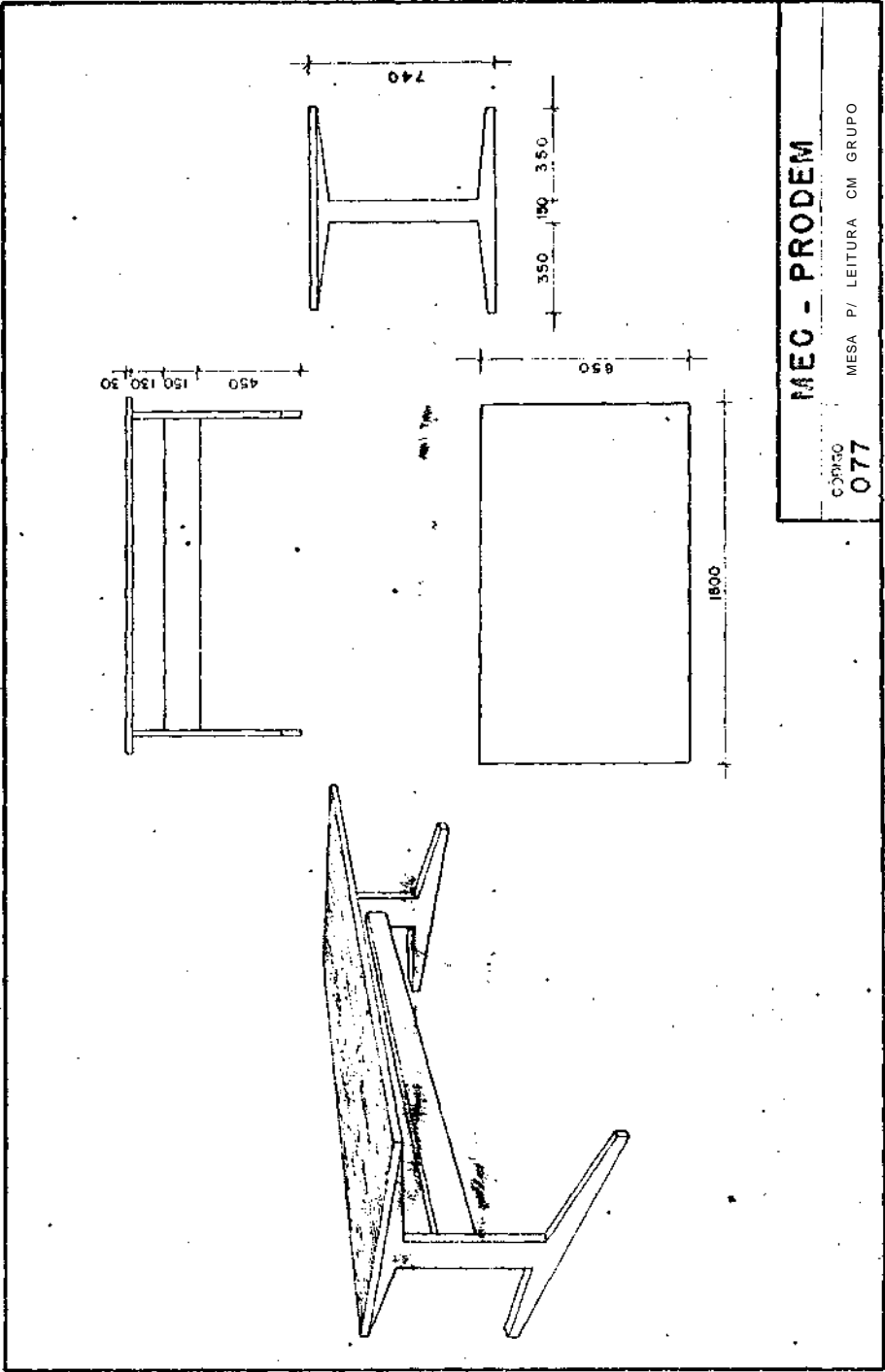

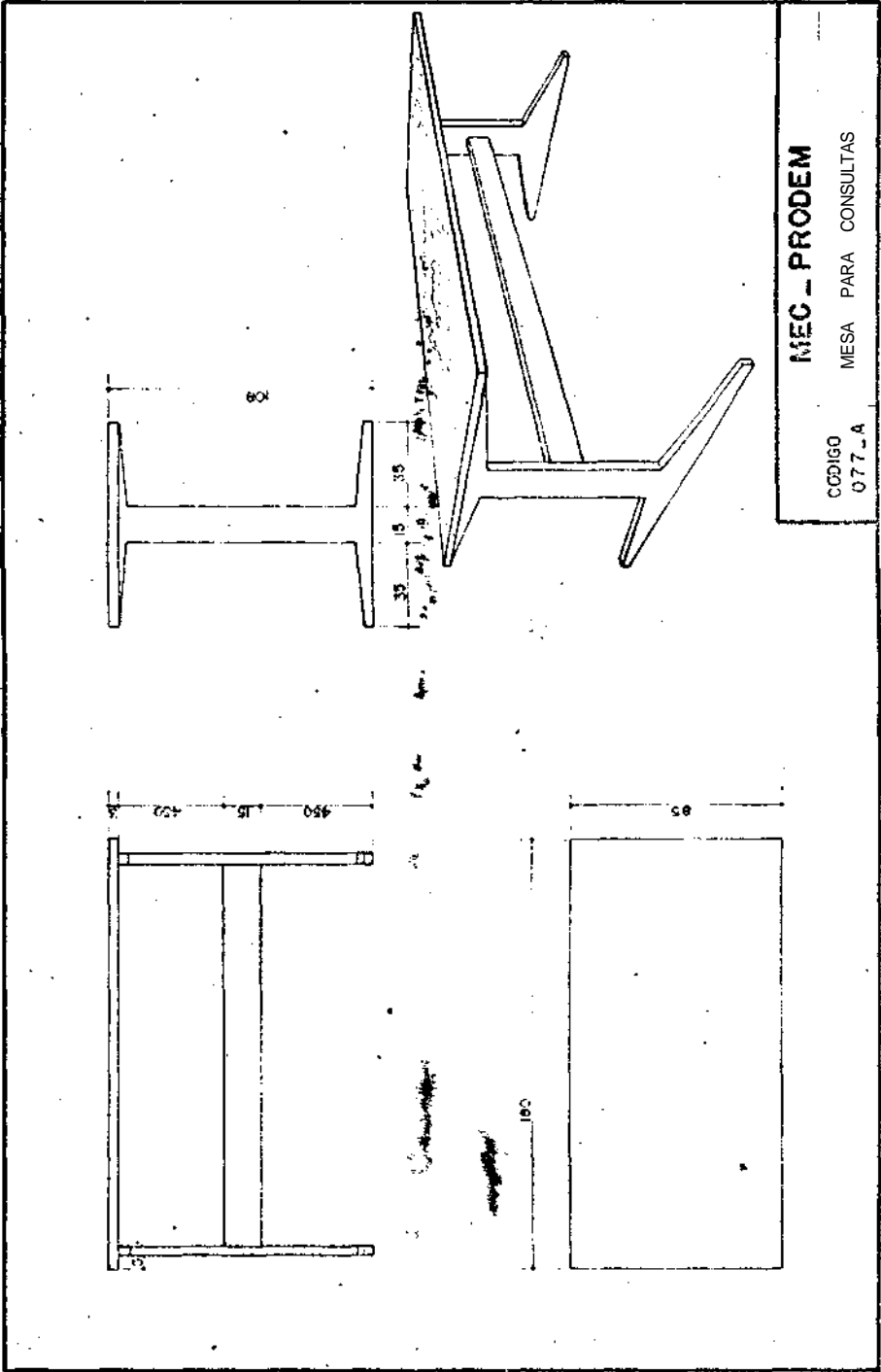

MEC _ PRODEM
CODIGO 077_A MESA PARA CONSULTAS

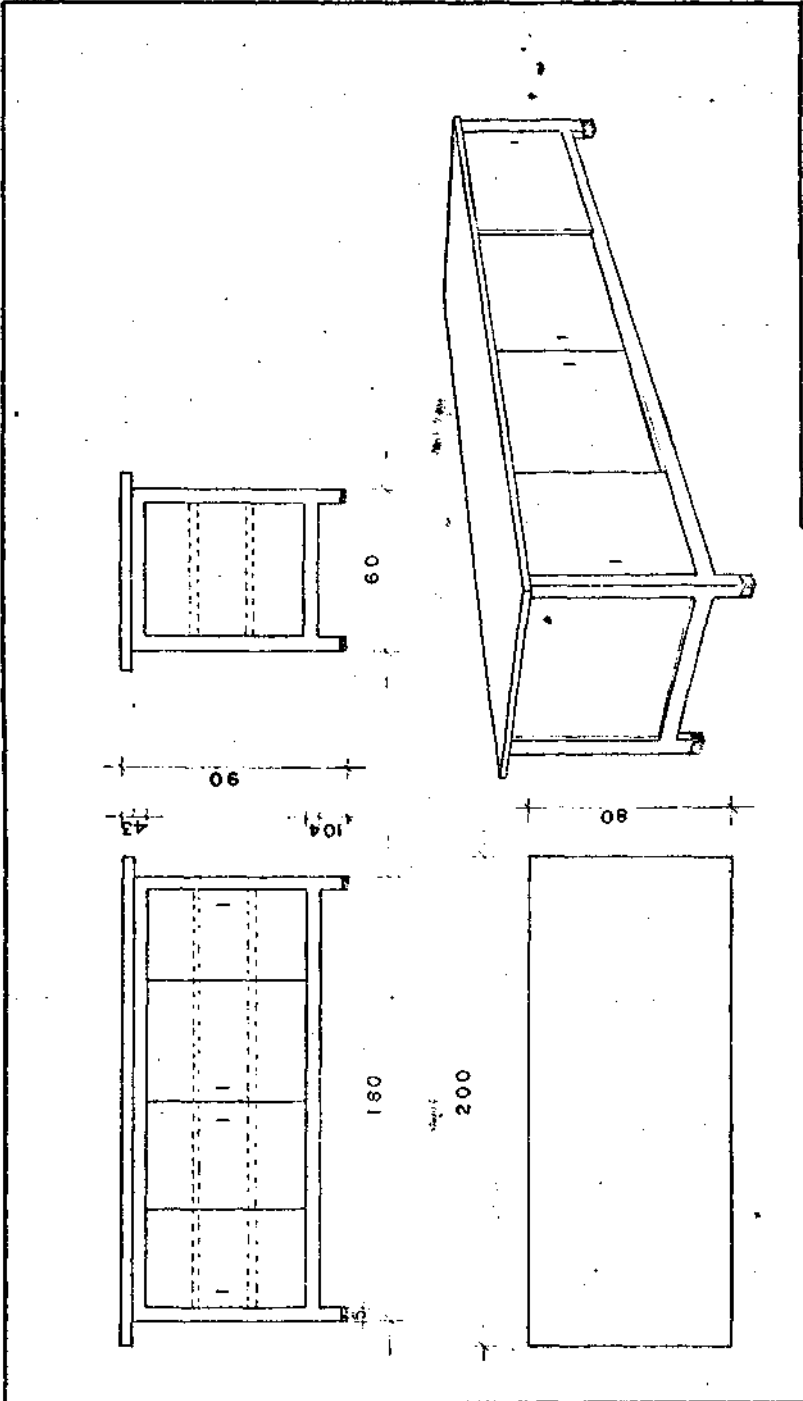

MEG-PRODEM
 CÓDIGO 07S BANCADA P/ POLITRIZES E LIXADEIRAS

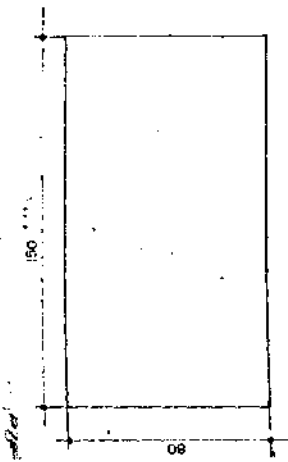
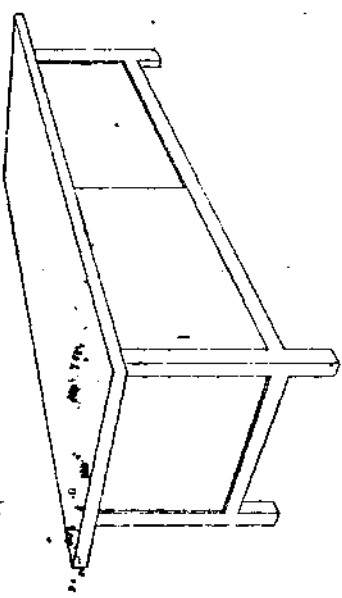
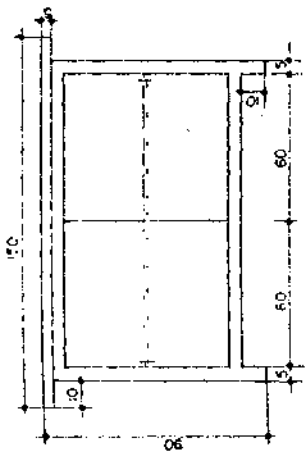
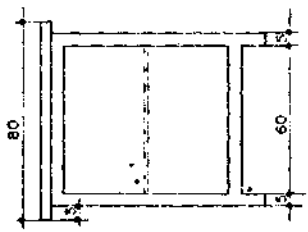

MEC-PRODEM
CADERNO 080 BANCAM COM ARMÁRIO

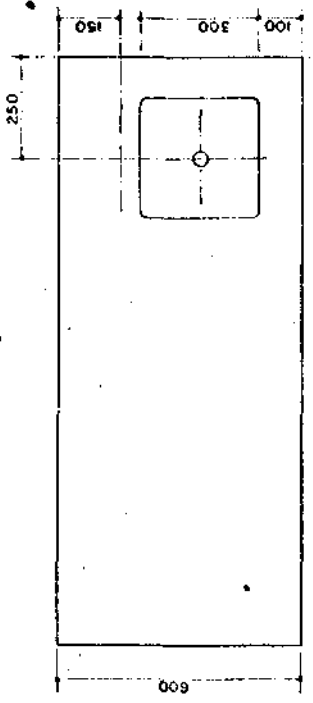
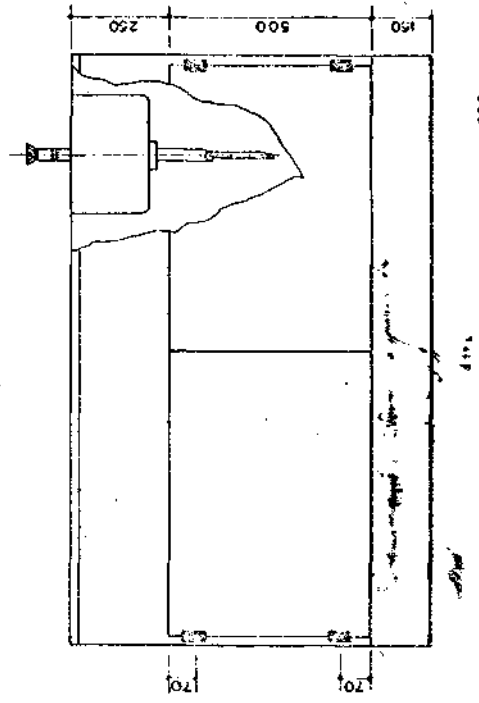
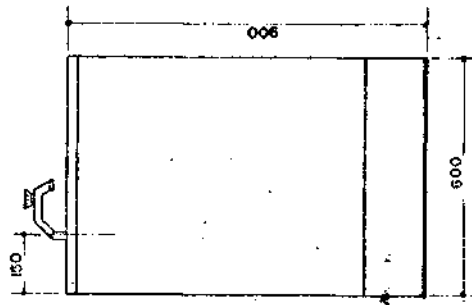

MEC_PRODEN	
CÓDIGO 051	BANCADA ARMÁRIO COM PIA DE AÇO

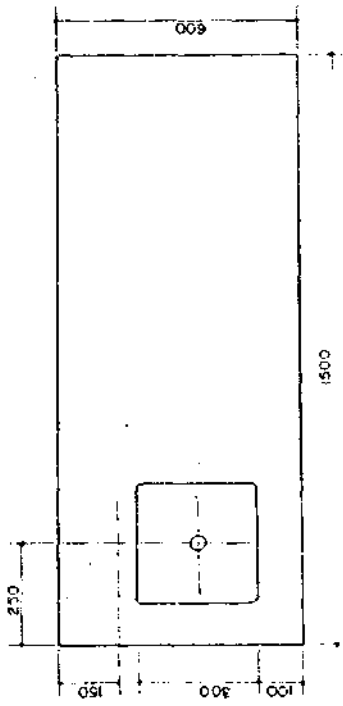
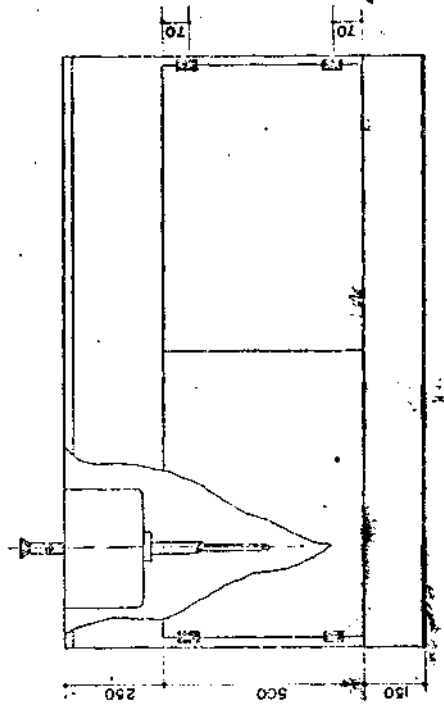
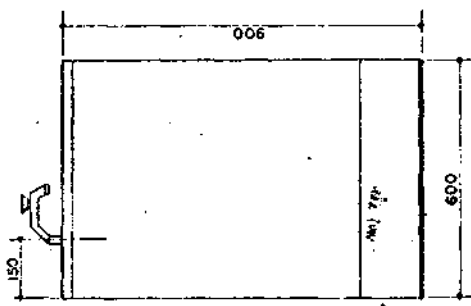

MEC_PRODTEM
 BANCADA AHMÁRIO COM PIA DE AÇO
 CÓDIGO 031.A

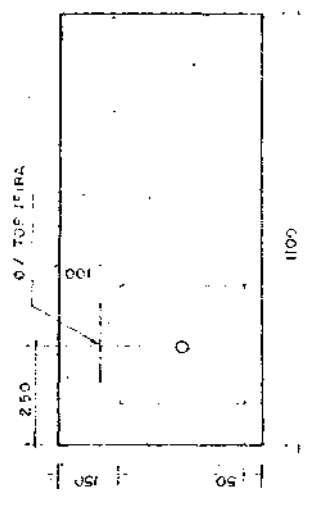
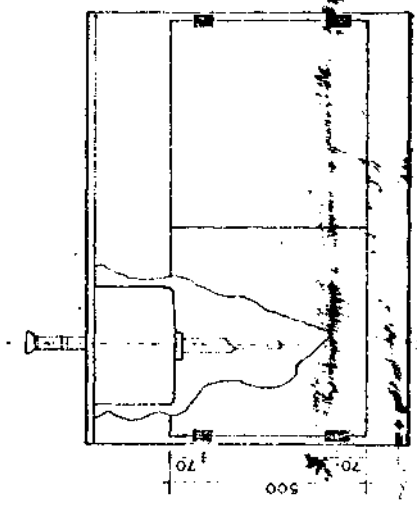
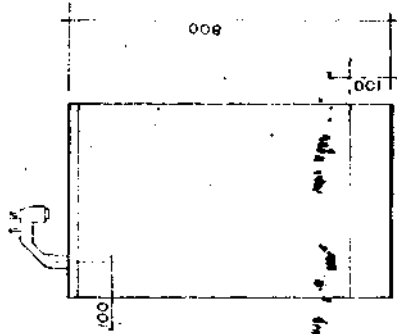

MEC-PRODEM

BANCADA ARMÁRIO C/ PIA

CCB:60

0 8 1 9

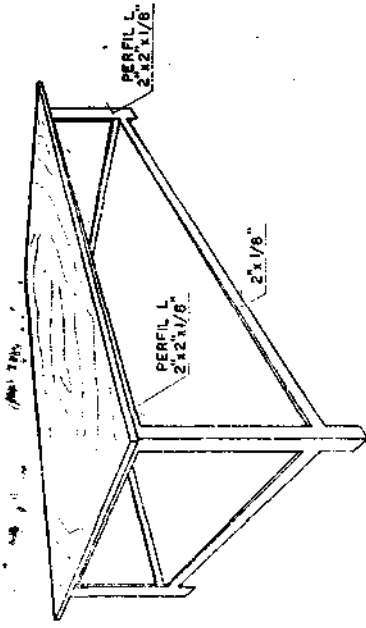
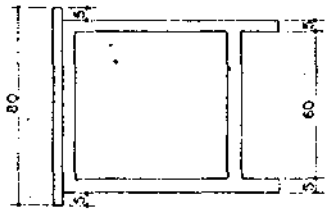
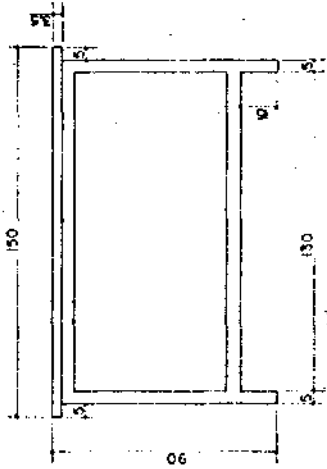

MEC - PRODEM	
CC016C	BANCADA-RESISTÊNCIA MATERIAS
082	

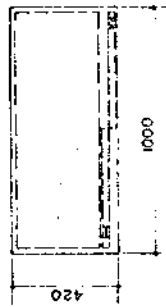
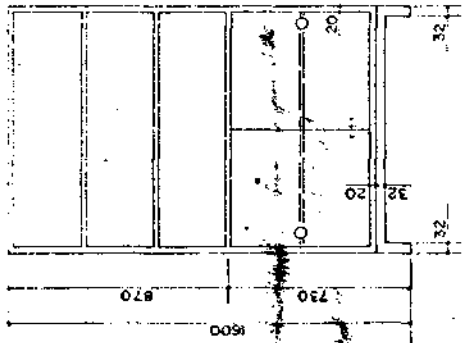
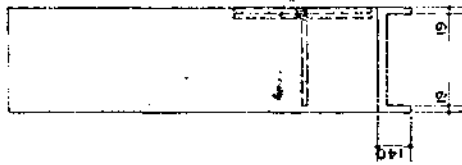
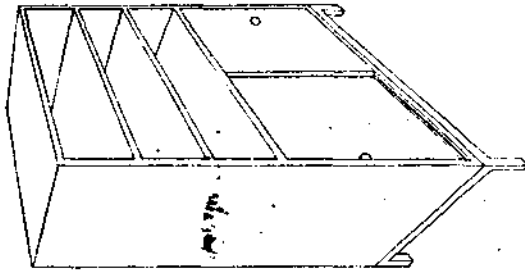

MEC - PRODEM	
CÓDIGO	ARMÁRIO ESTANTE
083	

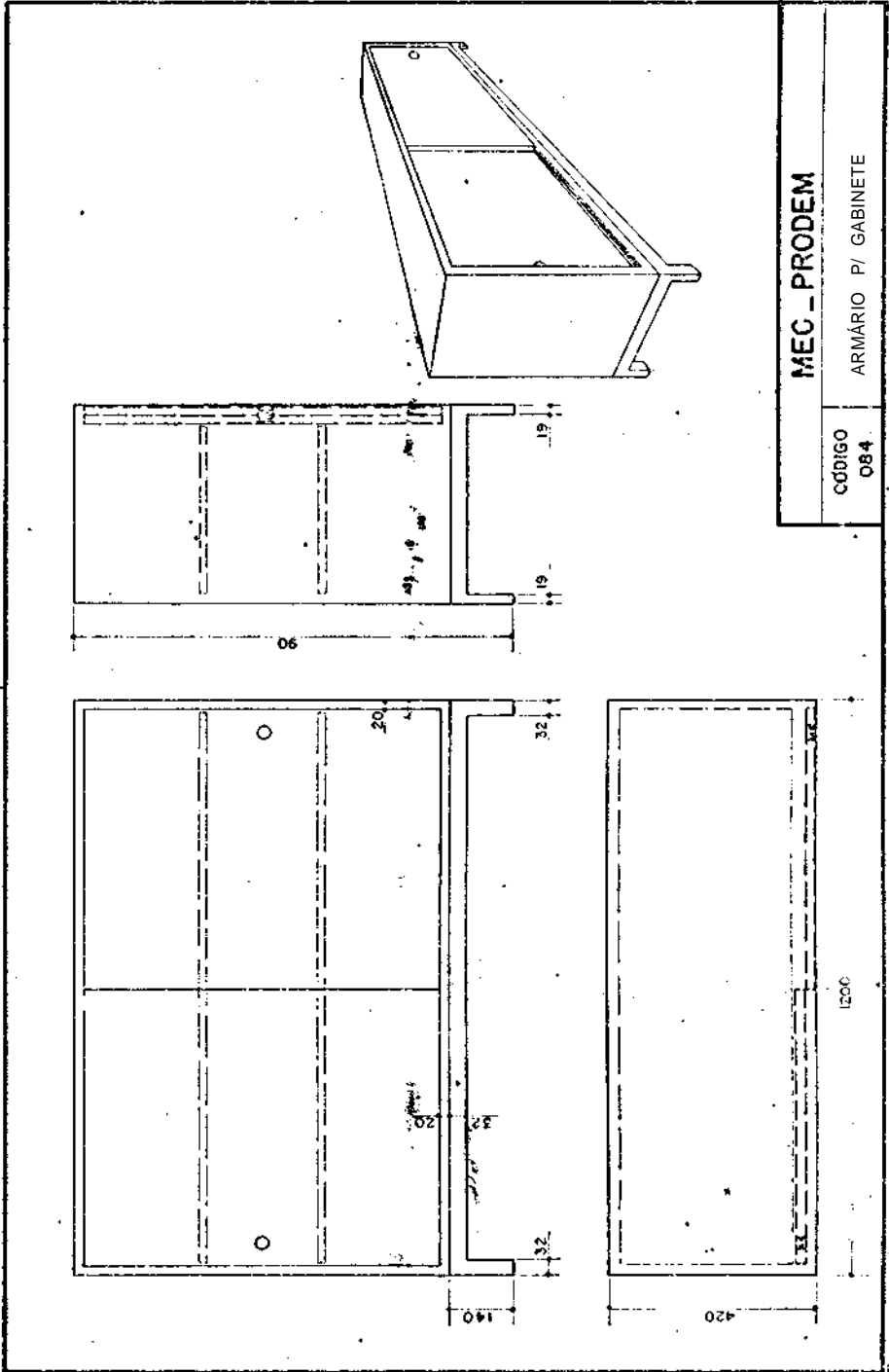

MEC _ PRODEM

CÓDIGO	ARMARIO P/ GABINETE
084	

1200

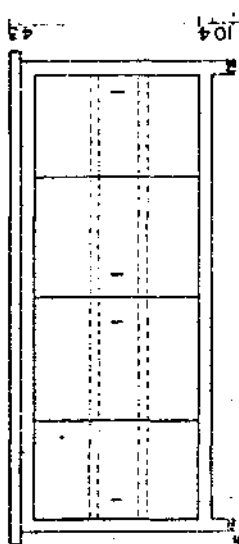
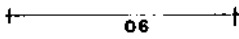
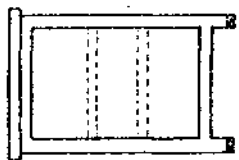

196

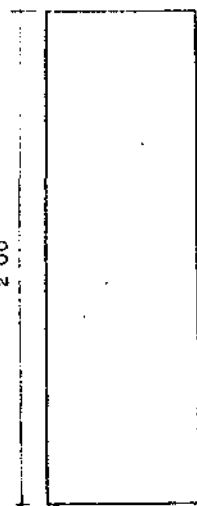
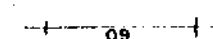
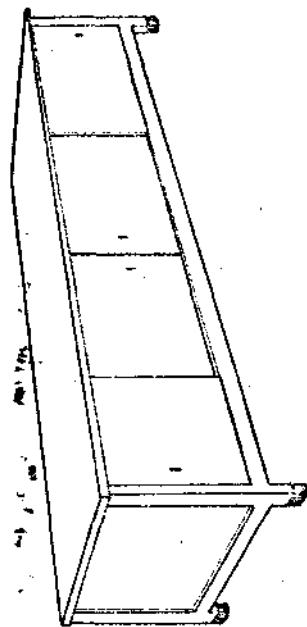

MEC - PRODEM

CÓDIGO
036

BANCADA C/ ARMÁRIO

DR.

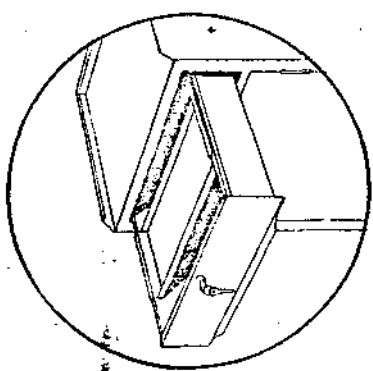
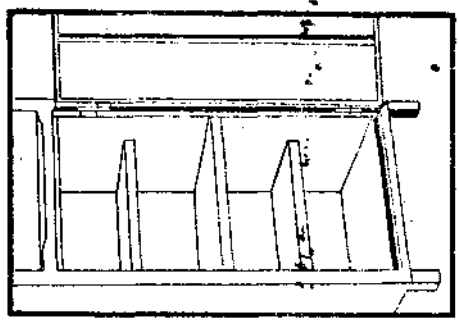
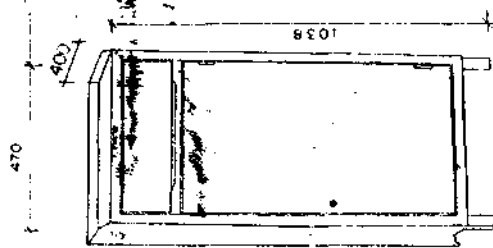

MEC-PRODEM

CÓDIGO 087

ARMÁRIO P/ FERRAMENTAS

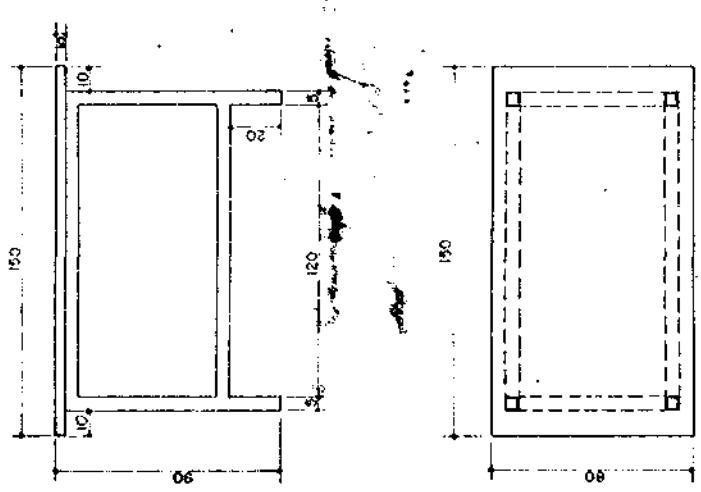
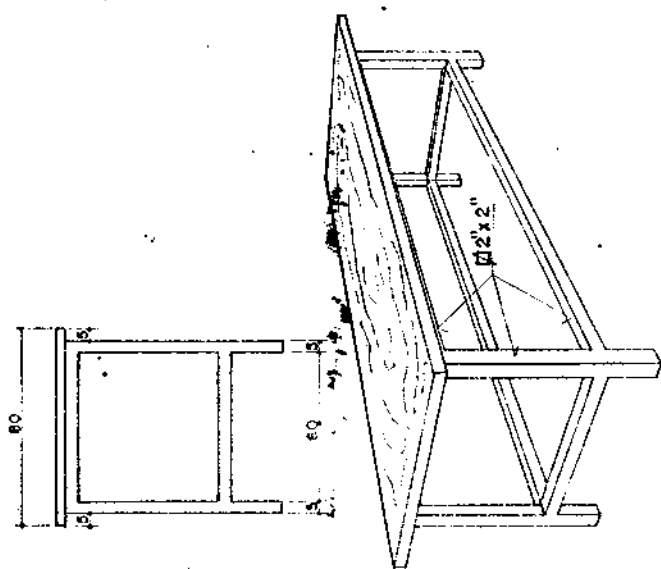

MEC_PRODEM

BANCAM P/ SISTEMAS DE CONTROLE

CÓD:160
088

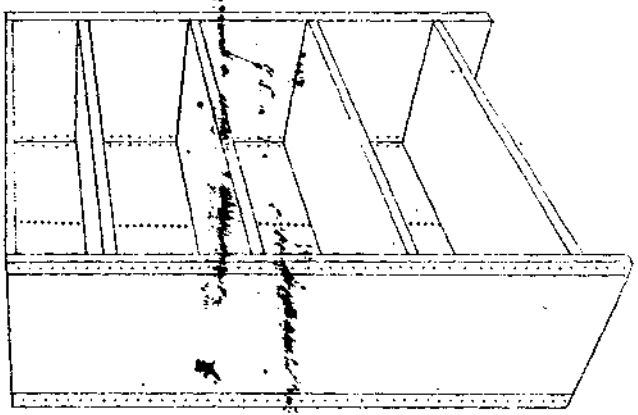
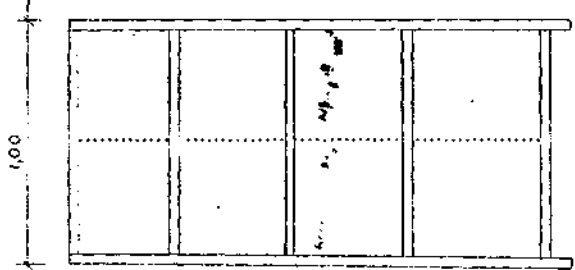
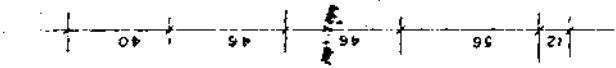
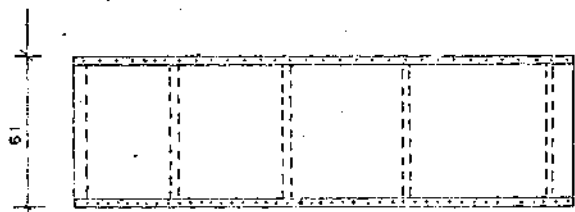

SECRETARIA EXECUTIVA - GERENCIA DE APOIO ADMINISTRATIVO

MEC - PRODEM

ESTANTE P/ MATERIAL

CÓDIGO: 089

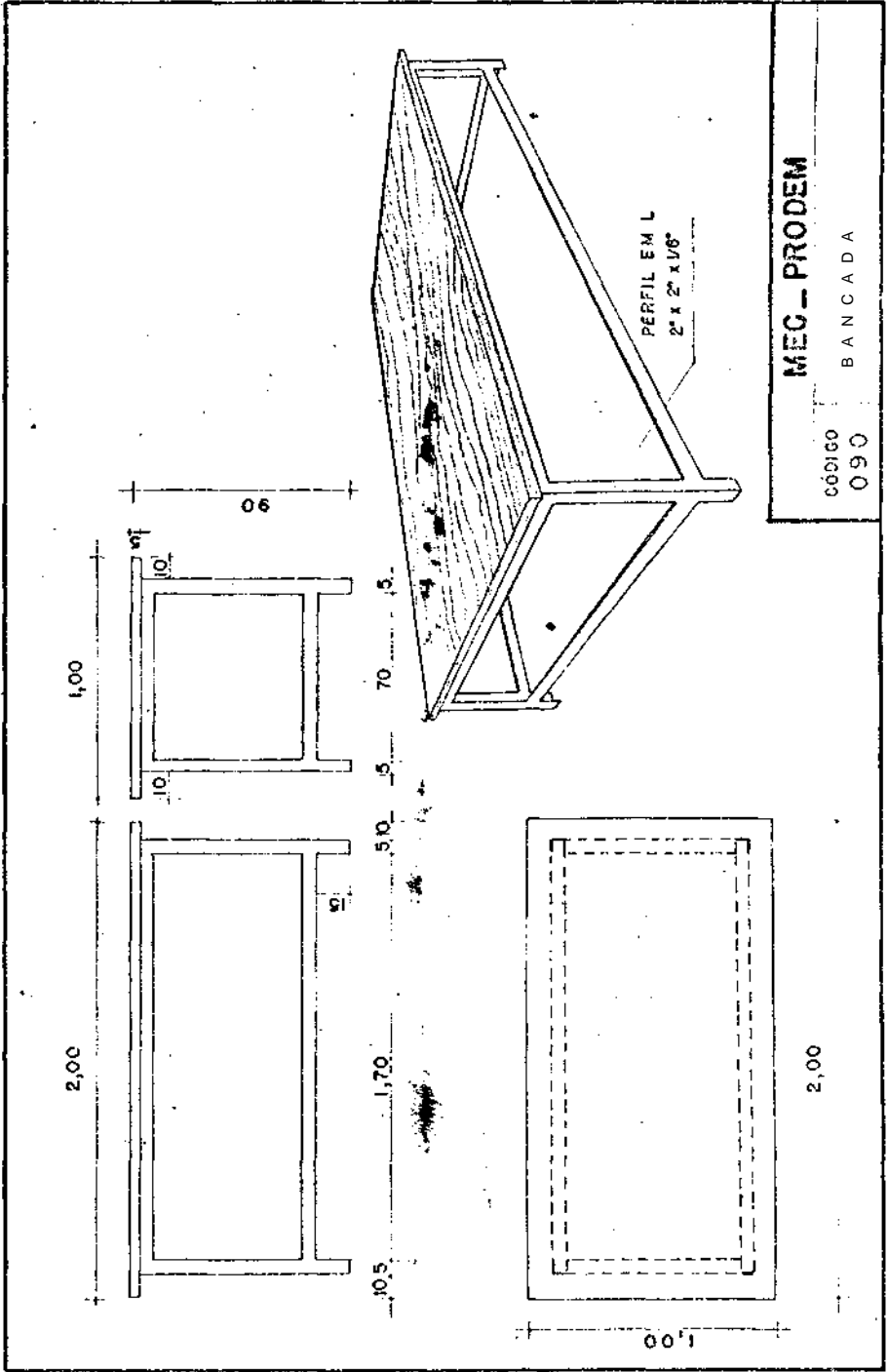

MEC - PRODEM

cópias
091

ESTANTE

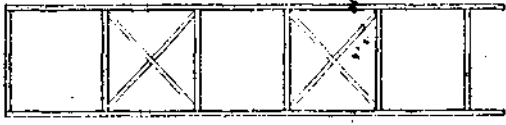
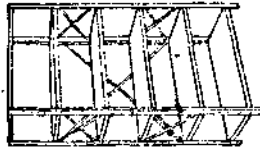

1940

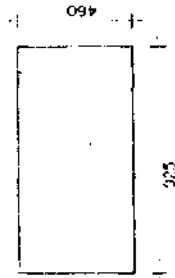
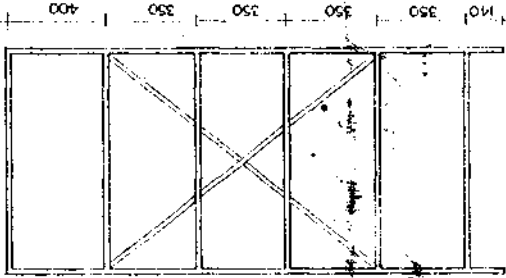

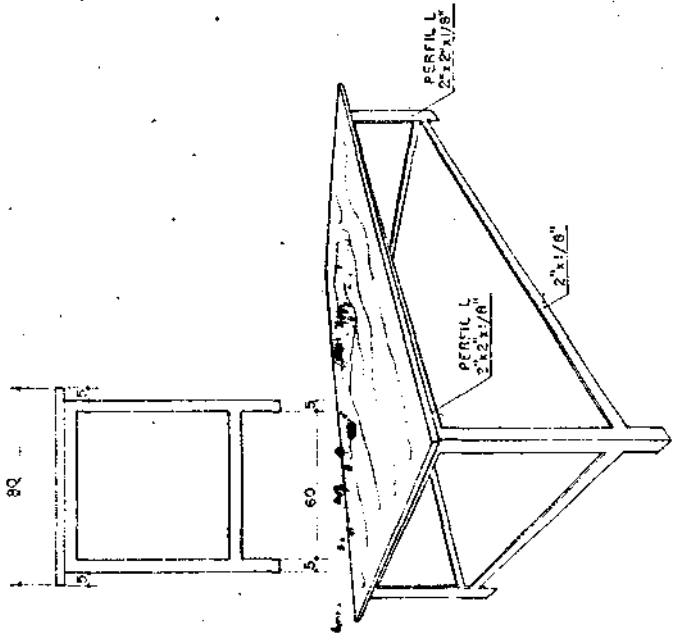
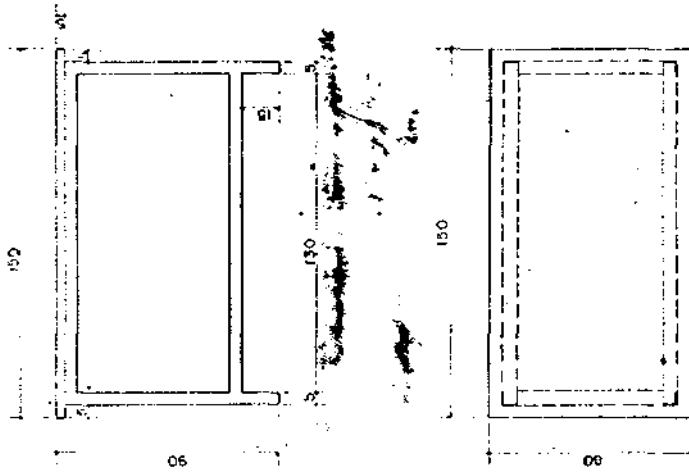

MEC - PRODEM
 BANCADA PARA ESMERIL E FURADEIRA

Código
092

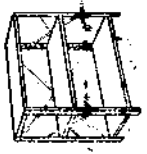
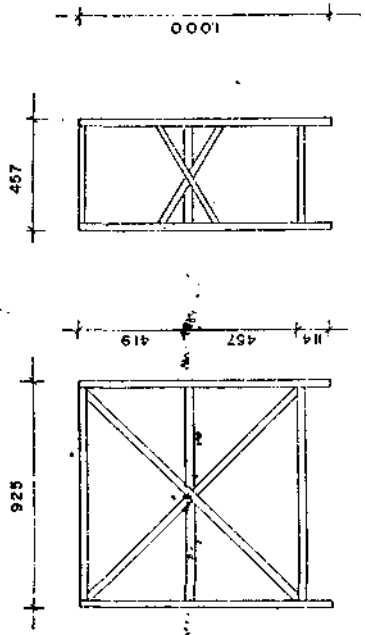

MEC - PRODEM
 ESTANTE
 código 093

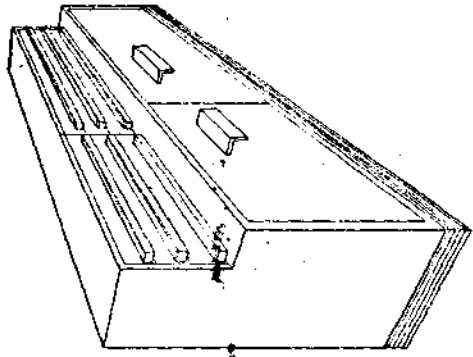
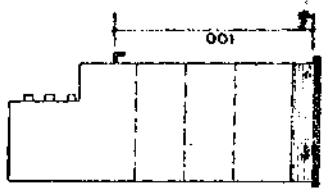
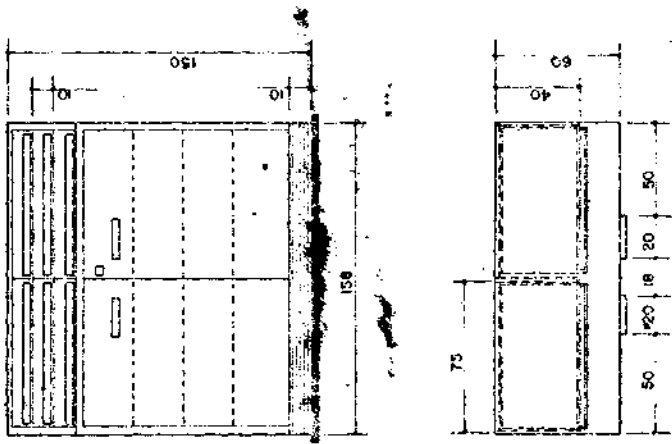

MEC - PRODEM
 cd/isco 094
 ARMÁRIO P/ ESTOCAR AMOSTRAS

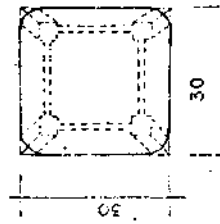
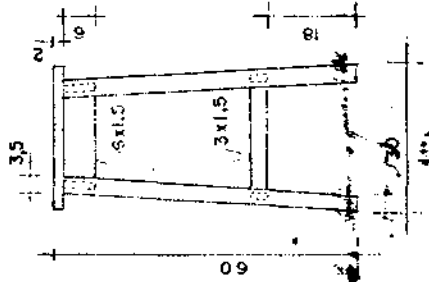
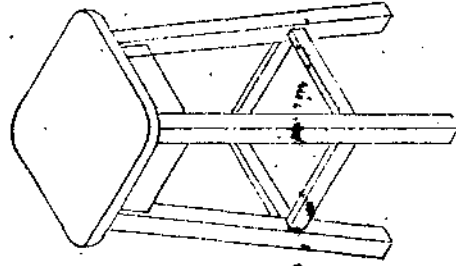

MEC PRODEM

CÓDIGO

095

BANCO

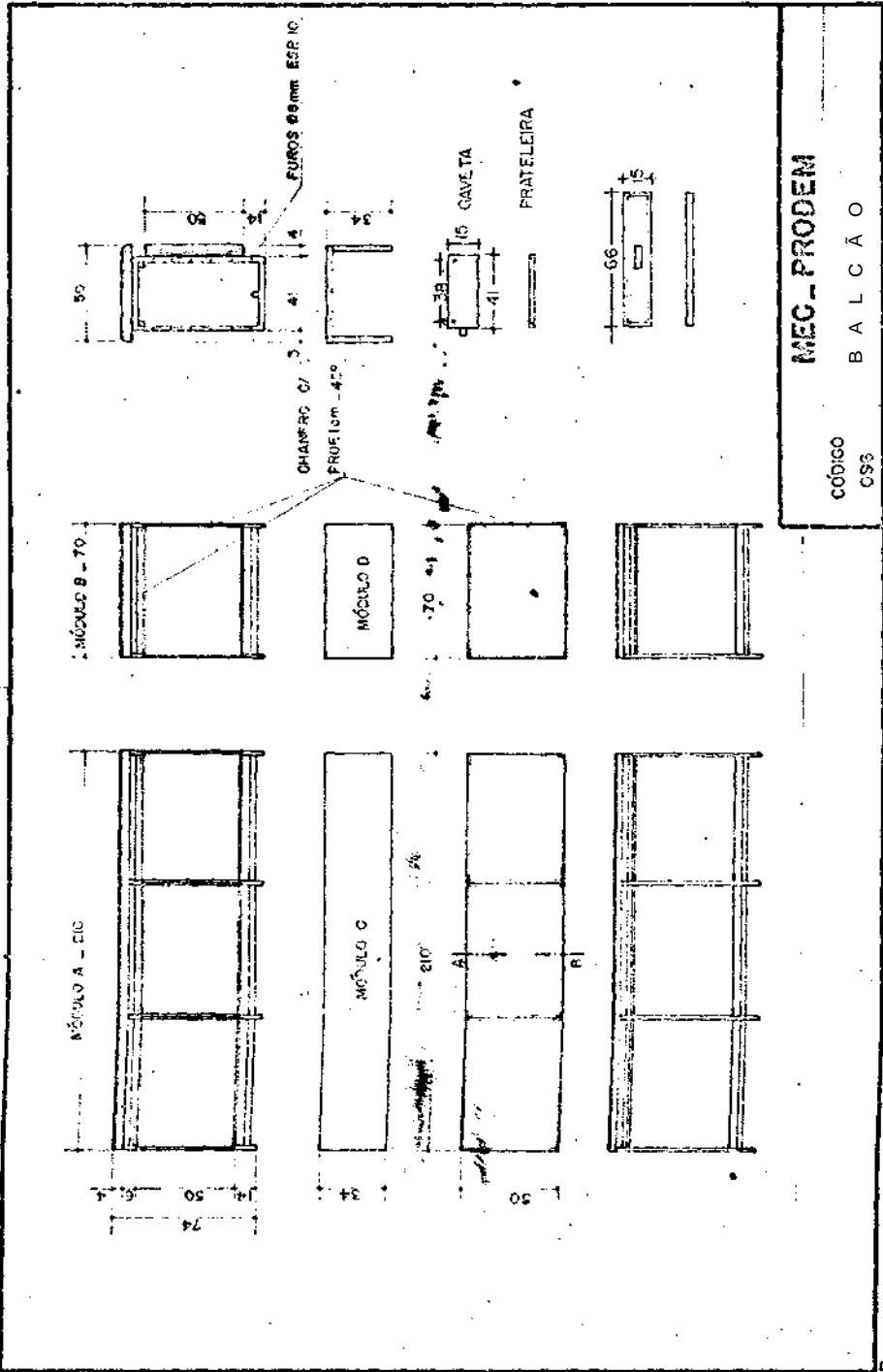

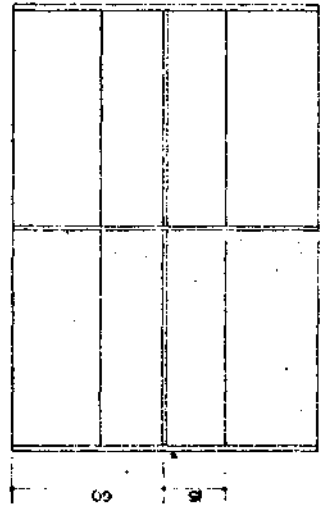
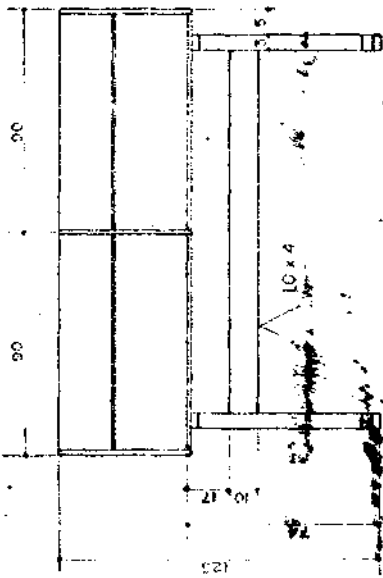
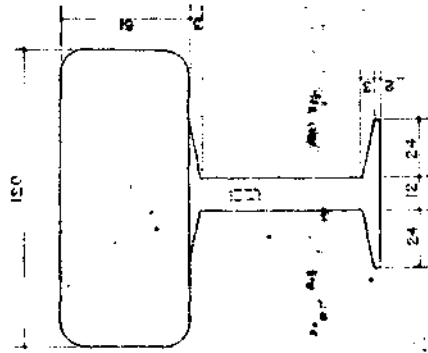

MEC_PRODEM

MESA P/ LEITURA COM ESTANTE

código

097

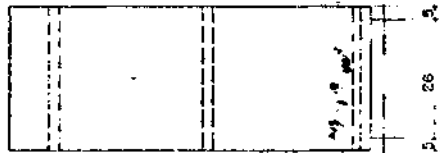
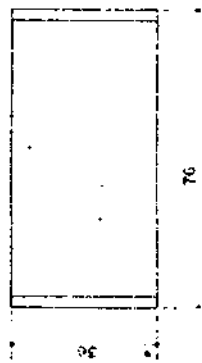
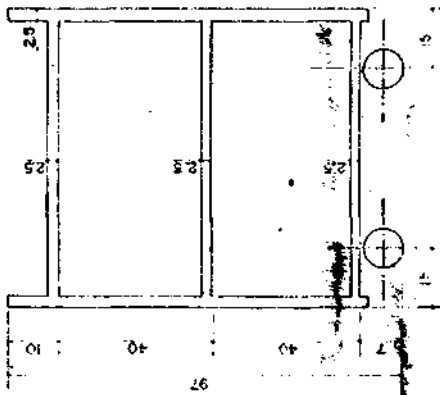

MEC_PRODEM
 CARRINHO P/ TRANSPORTE DE LIVROS
 CODIGO 058

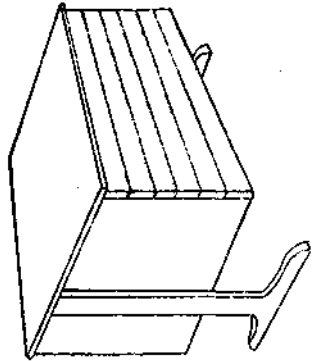
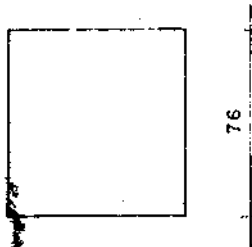
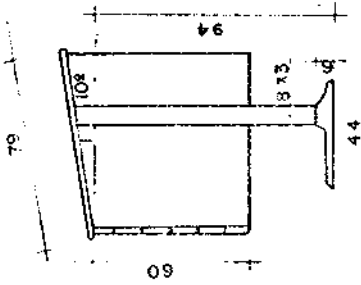
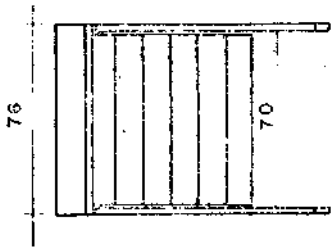

MEC - PRODEM
CÓDIGO 099 MESA PARA MAPAS

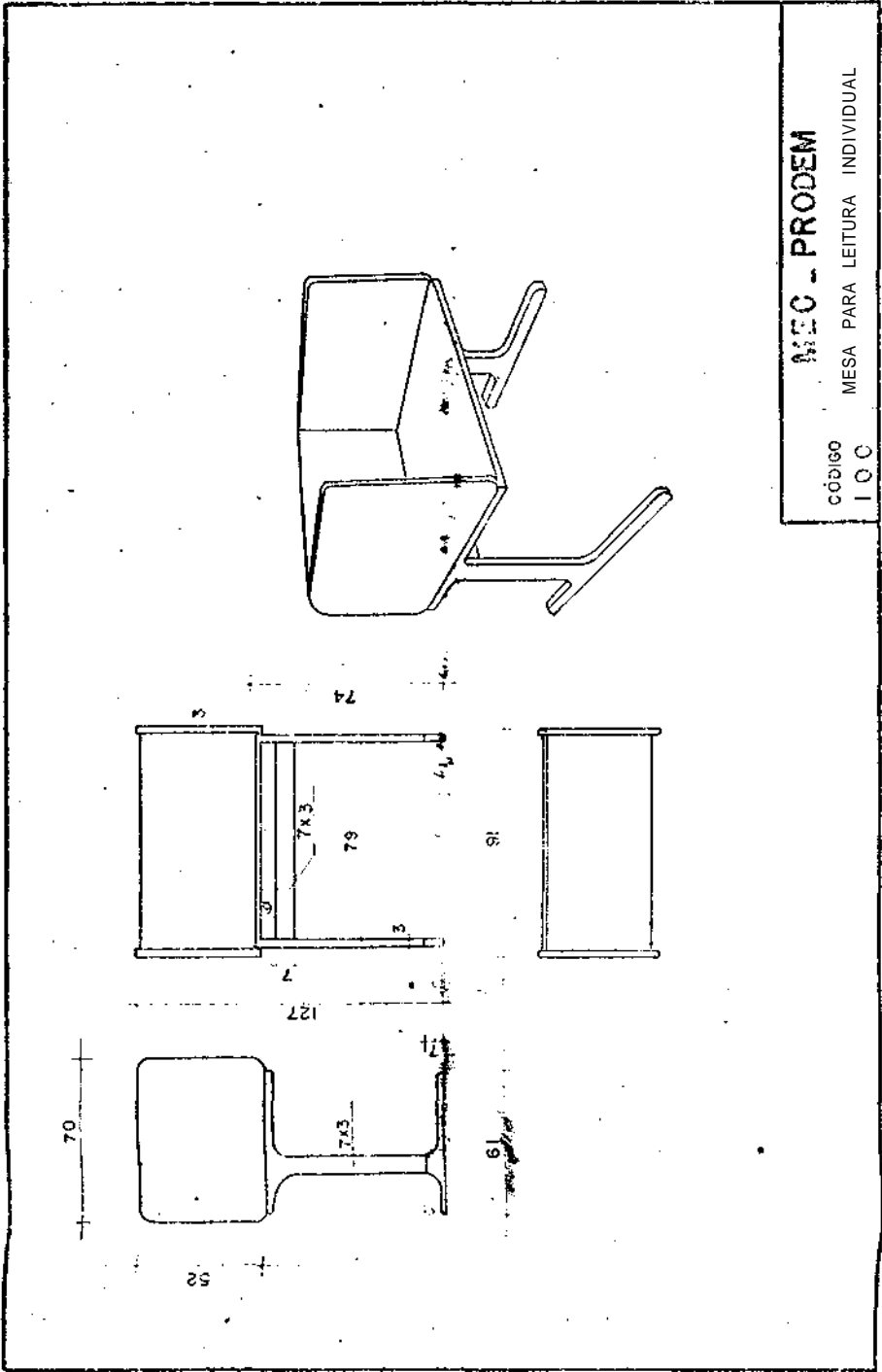

MEC - PRODEM

MESA PARA LEITURA INDIVIDUAL

CÓDIGO

100

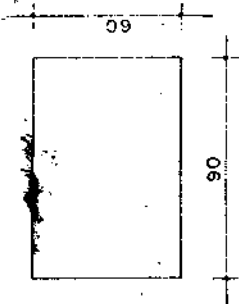
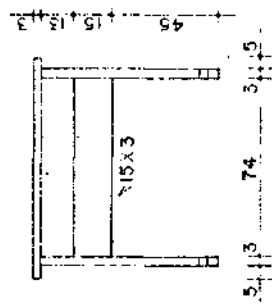
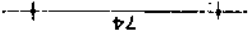
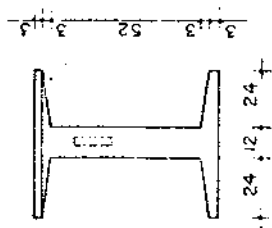

MEC_PROBEM	
CODIGO	PARA
101	LEITURA INDIVIDUAL

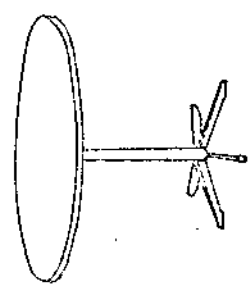
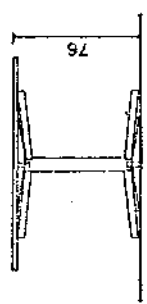
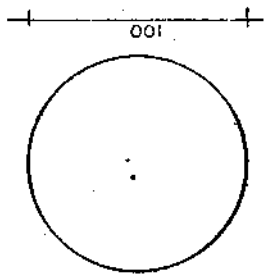

MEC-PRODEM

CODIGO
102

MESA P/ CANTINA

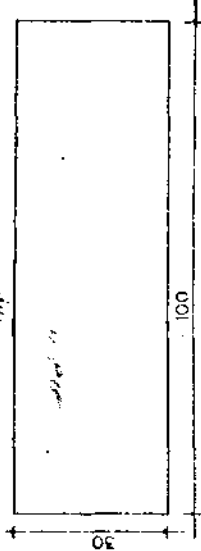
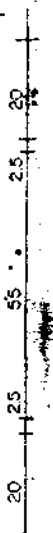
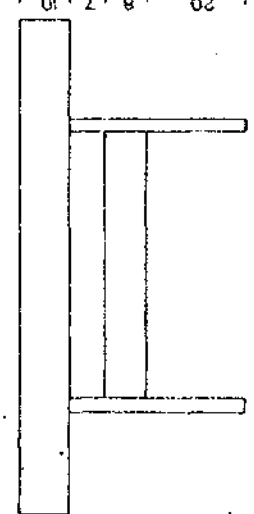
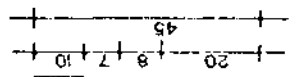
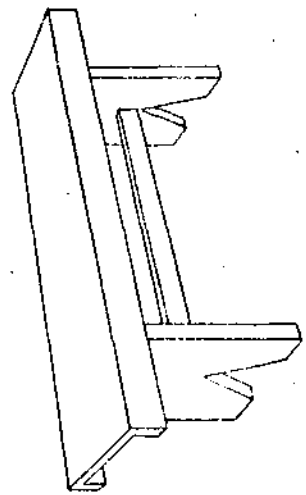
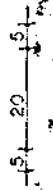
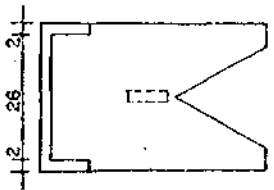

MEC-PRODEM
 BANCO TARA VESTIÁRIO
 Códigos 103

Livros Grátis

(<http://www.livrosgratis.com.br>)

Milhares de Livros para Download:

[Baixar livros de Administração](#)

[Baixar livros de Agronomia](#)

[Baixar livros de Arquitetura](#)

[Baixar livros de Artes](#)

[Baixar livros de Astronomia](#)

[Baixar livros de Biologia Geral](#)

[Baixar livros de Ciência da Computação](#)

[Baixar livros de Ciência da Informação](#)

[Baixar livros de Ciência Política](#)

[Baixar livros de Ciências da Saúde](#)

[Baixar livros de Comunicação](#)

[Baixar livros do Conselho Nacional de Educação - CNE](#)

[Baixar livros de Defesa civil](#)

[Baixar livros de Direito](#)

[Baixar livros de Direitos humanos](#)

[Baixar livros de Economia](#)

[Baixar livros de Economia Doméstica](#)

[Baixar livros de Educação](#)

[Baixar livros de Educação - Trânsito](#)

[Baixar livros de Educação Física](#)

[Baixar livros de Engenharia Aeroespacial](#)

[Baixar livros de Farmácia](#)

[Baixar livros de Filosofia](#)

[Baixar livros de Física](#)

[Baixar livros de Geociências](#)

[Baixar livros de Geografia](#)

[Baixar livros de História](#)

[Baixar livros de Línguas](#)

[Baixar livros de Literatura](#)
[Baixar livros de Literatura de Cordel](#)
[Baixar livros de Literatura Infantil](#)
[Baixar livros de Matemática](#)
[Baixar livros de Medicina](#)
[Baixar livros de Medicina Veterinária](#)
[Baixar livros de Meio Ambiente](#)
[Baixar livros de Meteorologia](#)
[Baixar Monografias e TCC](#)
[Baixar livros Multidisciplinar](#)
[Baixar livros de Música](#)
[Baixar livros de Psicologia](#)
[Baixar livros de Química](#)
[Baixar livros de Saúde Coletiva](#)
[Baixar livros de Serviço Social](#)
[Baixar livros de Sociologia](#)
[Baixar livros de Teologia](#)
[Baixar livros de Trabalho](#)
[Baixar livros de Turismo](#)