

CIBEC/INEP



B0029979



Satere-marwe
pusu etiat wemūre hap



37 (=81:81)
S253s

MEC/PNUD/OPISM

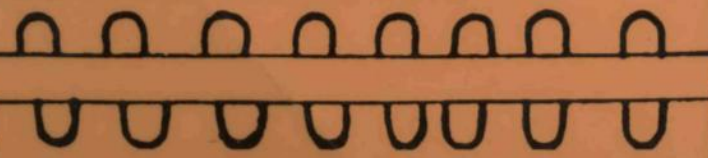

Livros Grátis

<http://www.livrosgratis.com.br>

Milhares de livros grátis para download.

Presidente da República:
Fernando Henrique Cardoso

Ministro de Estado da Educação e do Desporto:
Paulo Renato Souza

Secretário Executivo:
Luciano Oliva Patrício

Secretária de Educação Fundamental:
Iara Glória Areias Prado

do Departamento de Política da Educação Fundamental:
Virgínia Zélia de Azevedo Rebeis Farha

Coordenadora Geral de Apoio às Escolas Indígenas:
Ivete Maria Barbosa Madeira Campos

Equipe Técnica:
Caio Valério de Oliveira, Deuscreide Gonçalves Pereira, Deusalina Gomes
Eirão

Comité de Educação Escolar Indígena:
Iara Glória Areias Prado, Susana Martelleti Grillo Guimarães, Meiriel de Abreu Sousa, Luís Donisete Benzi Grupioni, Silvio Coelho dos Santos, Aldir Santos de Paula, Rosely Maria de Souza Lacerda, Sebastião Mário Lemos Duarte da Costa, Jadir Neves da Silva, Darlene Yaminalo Taukame, Alice Oliveira Machado, Valmir Jesi Cipriano, Bruno Ferreira, Algemiro da Silva, Salvino dos Santos Brás, Nietta Lindenberg Monte, Marina da Silva Kahn, Bruna Franchetto, Terezinha de Jesus Machado Maher, Nilmar Gavino Ruiz, Marivânia Leonor Furtado Ferreira, Júlio Wiggers e Álvaro Barros da Silveira. Gersen José Luciano Baniwa e Waldeclace Batista dos Santos

Publicação financiada pelo MEC - Ministério da Educação e do Desporto, dentro do Programa de Promoção e divulgação de Materiais Didático-Pedagógicos sobre as Sociedades Indígenas Brasileiras, recomendada pelo Comité de Educação Escolar Indígena.

Satere - Mawe pusu etiat wemu'e hap

Este material foi elaborado com os professores Sateré-Mawé no contexto do Projeto de Educação Indígena que desenvolvemos na área do Marau - Maués(AM) - com o apoio da O.N.G espanhola Ameríndia Cooperação/Plenty.

Organização :
Dulce Franceschini

Participação dos seguintes Sateré-Mawó :

Ilustrações:
Ednelson Cristino
Erinaldo Miquiles
Inácio Cristino da Silva
Rosenildo Sérgio da Silva

Capa : *Puratig* de Nova Esperança — Marau
Ednelson Cristino

Revisão:
Bernardo Alves
Euro Alves
Rosenildo Sérgio da Silva

Diagramação:
Dulce Franceschini

Arte Final:
Pierre-Louis André Ferrandis



Apoio:
Ameríndia Cooperação

Direitos Autorais:
O.R.I.S.M. (Organização dos Professores Indígenas Sateré-Mawé)
Maués (AM) - 1997



Apresentação

Esta cartilha é o resultado de 4 anos de pesquisa-ação entre os Sateré-mawé e foi feita com a participação dos professores indígenas da zona do Marau-Urupadi (Maués-AM) corrigindo a escrita, decidindo sobre o sistema ortográfico, desenhando, etc...

Com a elaboração desta cartilha pretendemos contribuir para a melhoria da educação escolar Sateré-Mawé a qual não pode ser pretendida sem que ocorra ao mesmo tempo uma revalorização da cultura indígena. A revalorização das culturas indígenas só será possível se houver o respeito das diferenças linguística e cultural das mesmas.

Respeitar a diferença significa, no âmbito escolar, tomar a língua indígena como eixo que possibilita que a educação da criança seja calcada na sua própria realidade sócio-histórica e cultural e que a criança reflita e atue sobre ela, servindo-se de seu próprio referencial, de sua própria visão do mundo.

Esperamos que esse trabalho possa, viabilizando a alfabetização na língua materna, contribuir à valorização da língua e cultura indígena e promover um processo de ensino-aprendizagem fundado na cultura Sateré-Mawé.

Etimovekuap mitiḡtiḡ upī.

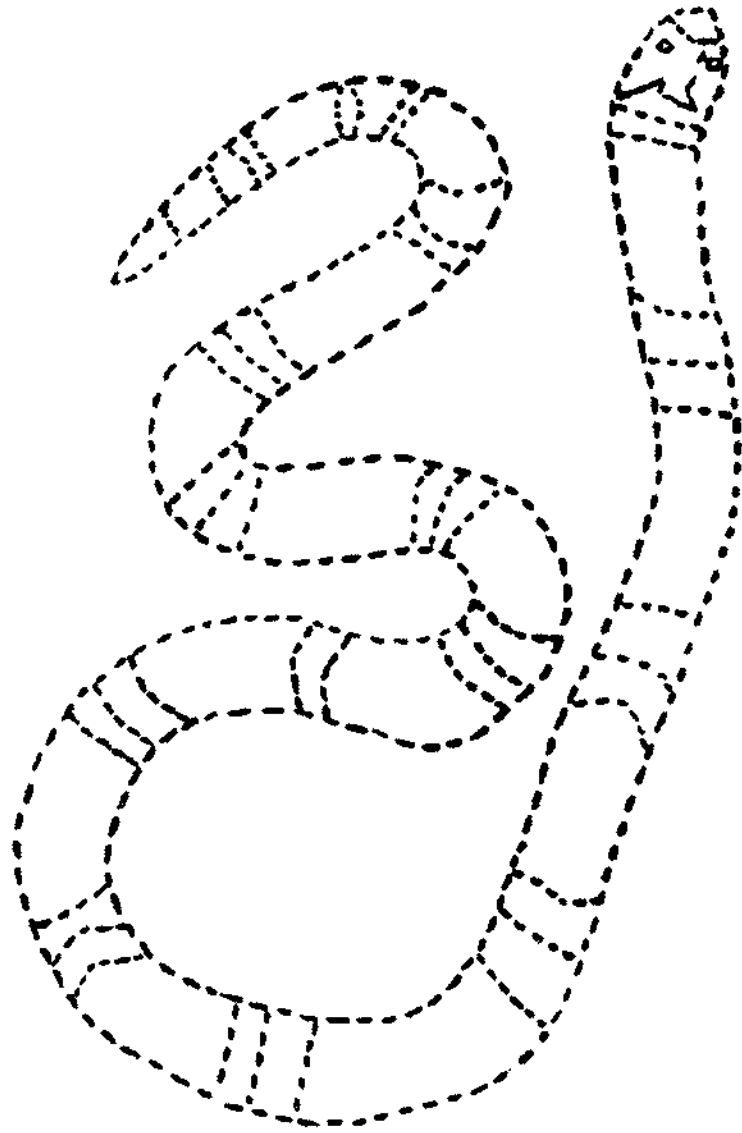

Moi man-ampe irywoq.

aware

a

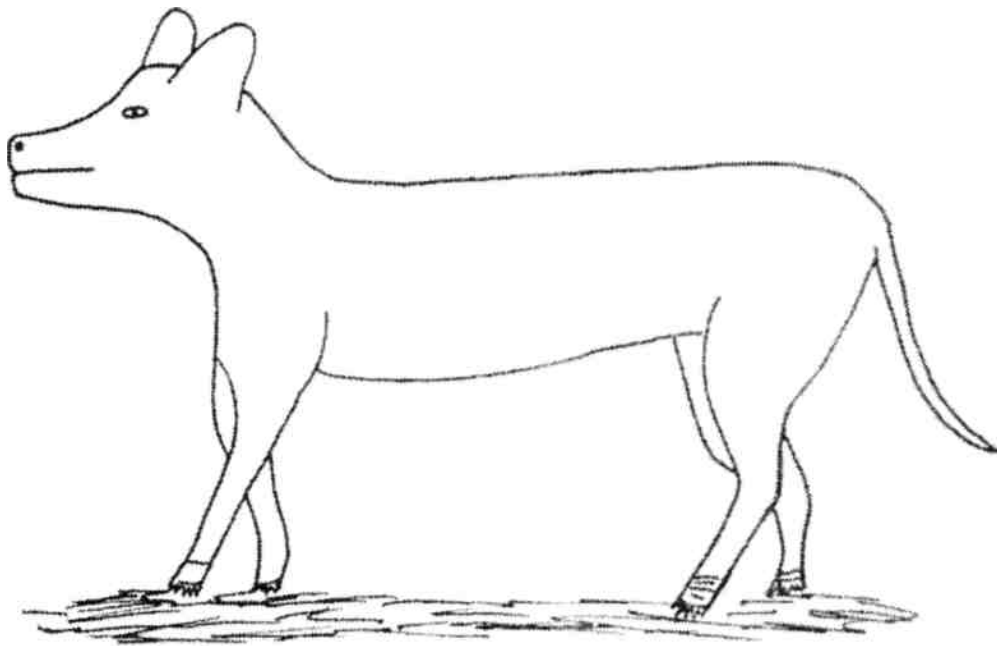

Aware henry.

A

a

Aware

aware

Etimohyrjyr heraǵkap miri harwji
etirwan sehary i:rywytrokpy pe.

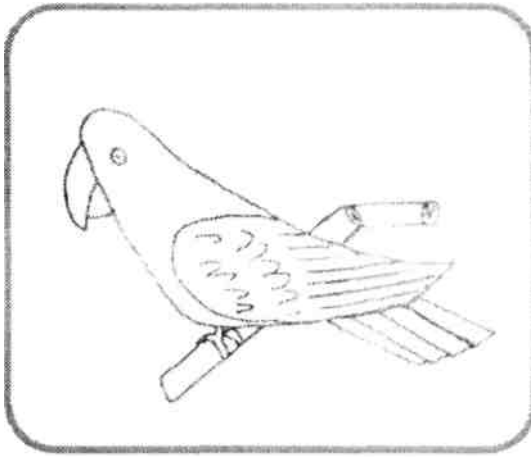

ahut
hut



aria
ri

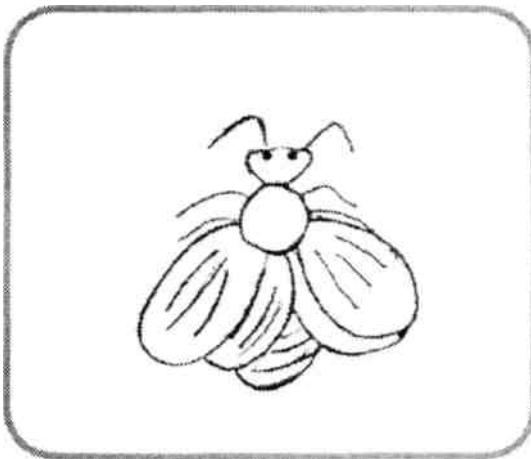

awia
wi?

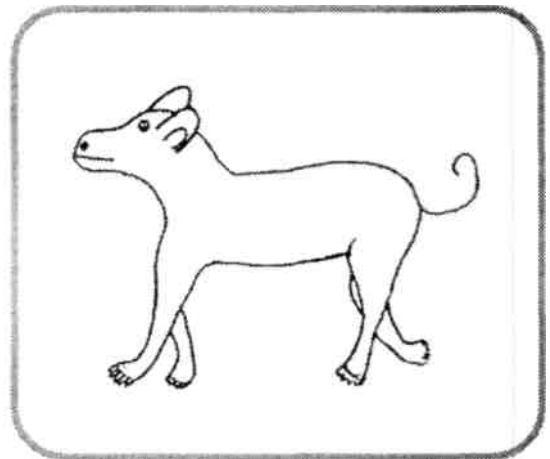

aware
ware



mau'a
m u'



warana
w r n



wa'asa
w ' s

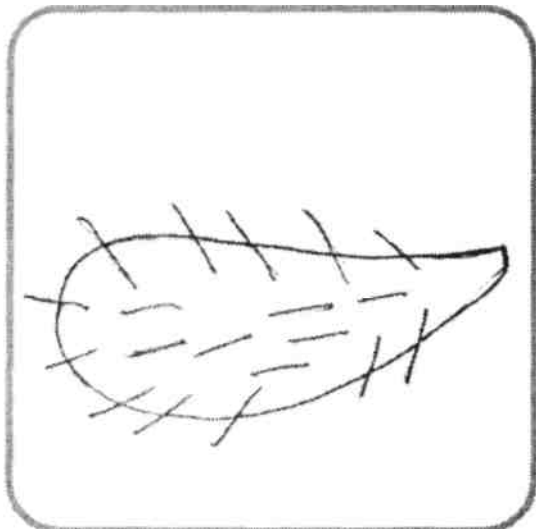

arwai'a
w i'

Etunuḡ nana ehu miʻi karuʻi
etimohyrūpi.

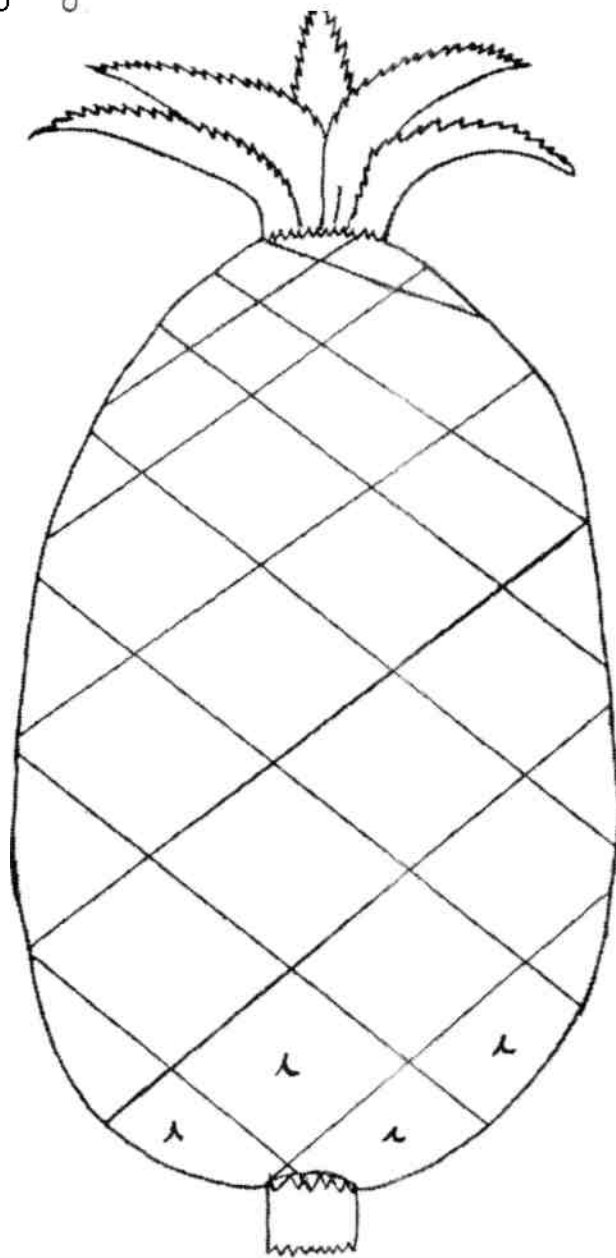

Nana hē kahato.

Etinywīt heragkap kori toro-ary wat
kape miri haruji etiratusetwan.

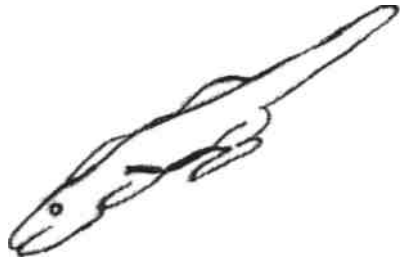

sara

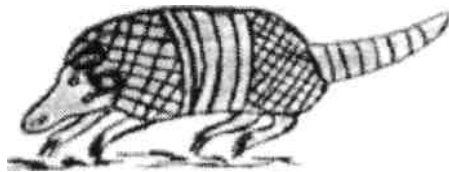
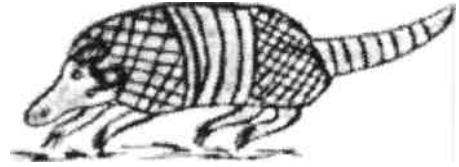

sahu



pira

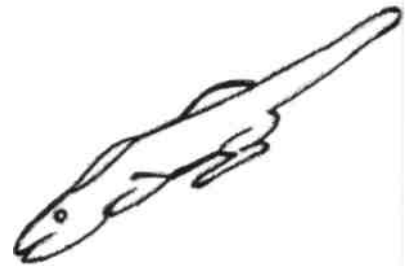

Etovam torovatri torovatri miri te
atunuq ere.

arwira

--	--	--	--	--	--

aria

--	--	--	--

arware

--	--	--	--	--	--

ahut

--	--	--	--

maura

--	--	--	--	--	--

warana

--	--	--	--	--	--	--	--

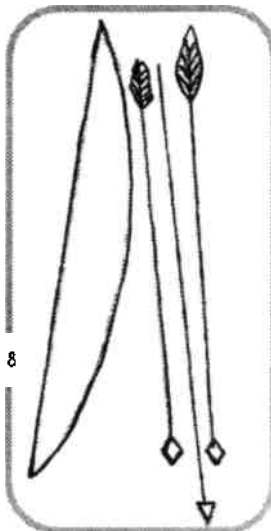

ehary kori herai
ryi etirvan het.
e aria ahut

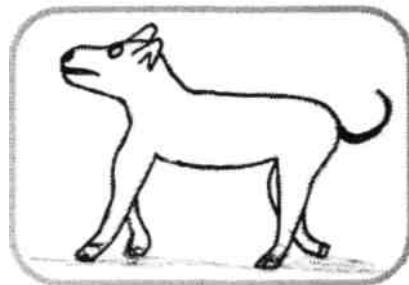

wre
re
e

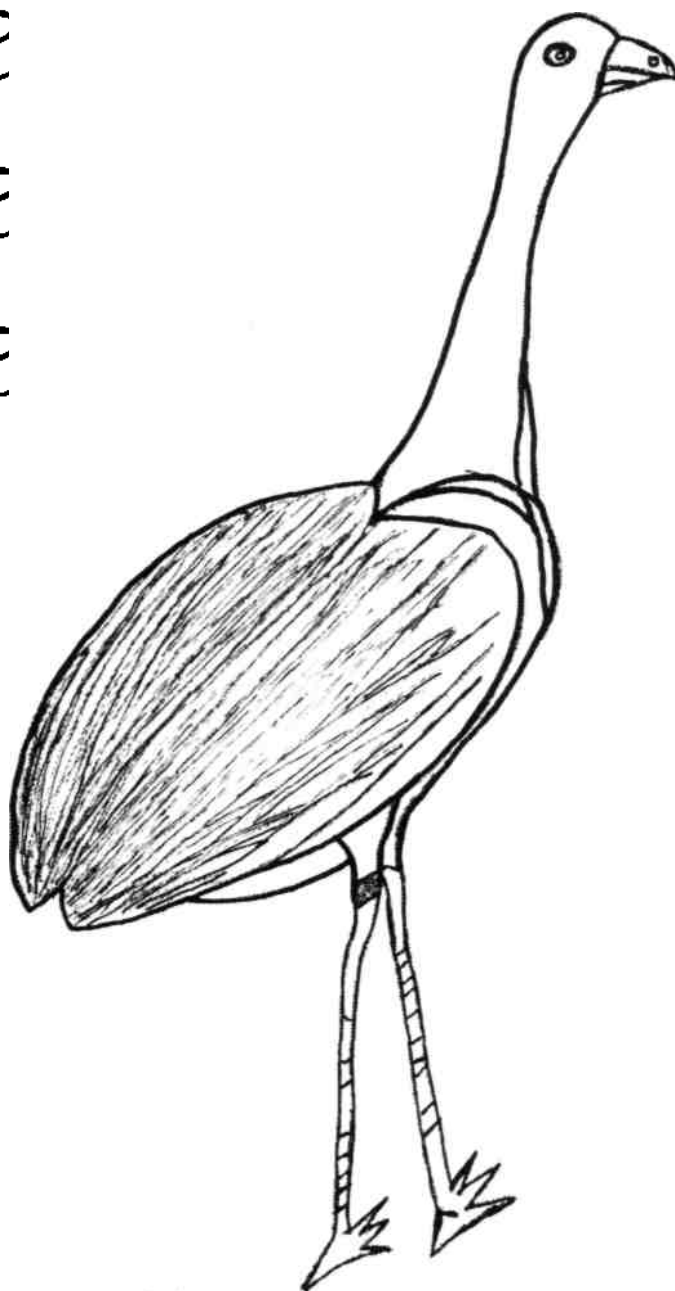

Уре топоры.

8

e

wre

Etimohyrjyp miri karvyi etirvan
iratuset kori.

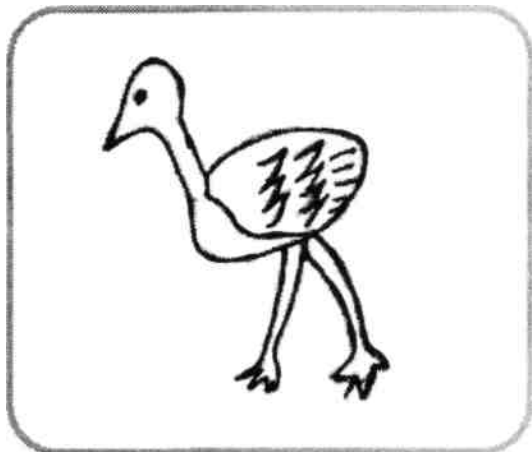

ure
ur

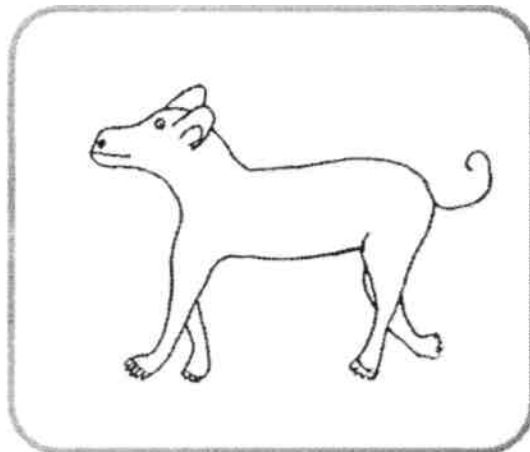

arware
arwar

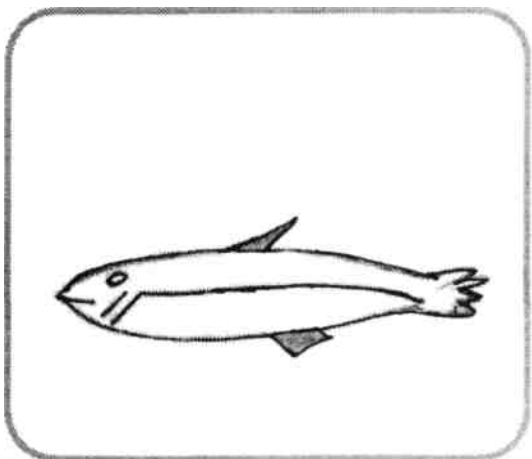

weru
w ri

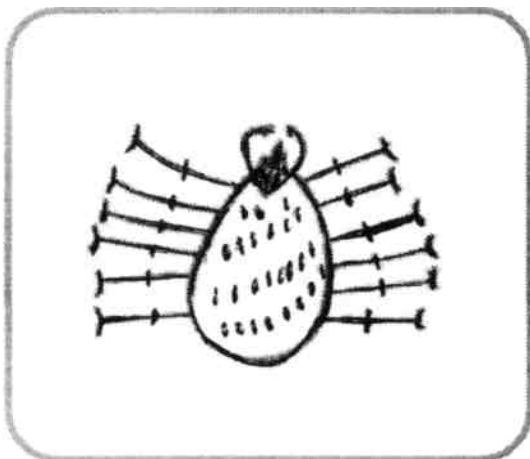

werwät
w wät

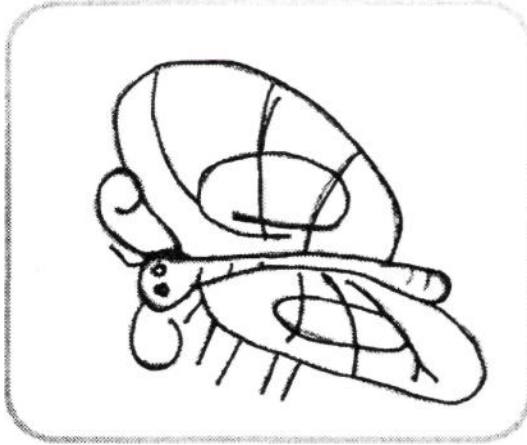

moreperi
mor p ri

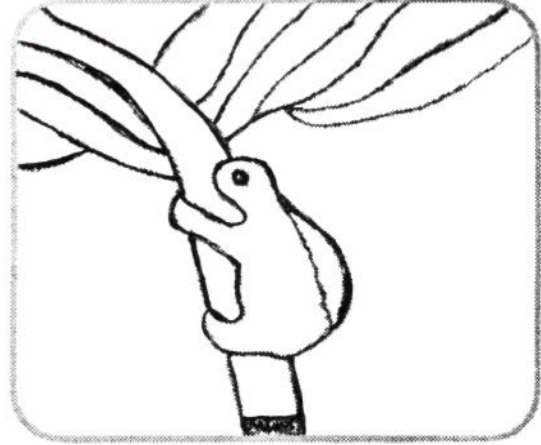

ariukere
ariuk r

Etimowepāp miʻi haruʻji eheʻaḡkapsat.

1. Aʻware toket.

2. Ariukere ḡaʻapʻy pe.

3. Weri yʻy pe.

Etinywāt sehary heraġkap kape.

ikary

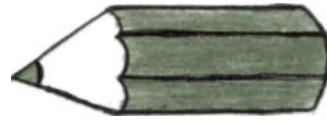

ihyrġp



ihup

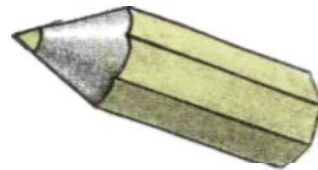

Etinywāt sehary kori torerowi.

werwāt

ūre

moreperi

weri

moreperi

weri

werwāt

ūre



Moreperi ikahu
kahato!

Etimohyrjyri tukupterem tarwa piat rakaria.

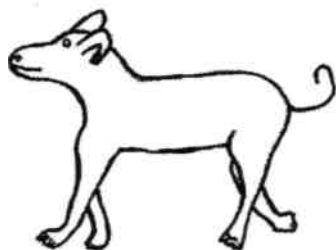

arware



pisana

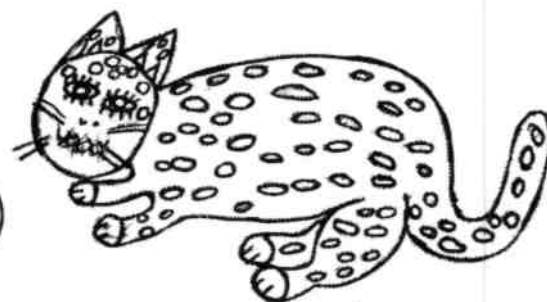

arwyato



hanuram



waipaka

Etowan torowatri torowatri miri te atunuḡ ere.

netap

--	--	--	--	--

eriat

--	--	--	--

ure

--	--	--

sokpe

--	--	--	--	--

muse

--	--	--	--

pira

pi

i

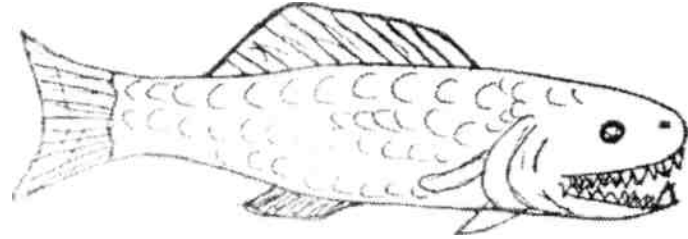

mani

ni

i

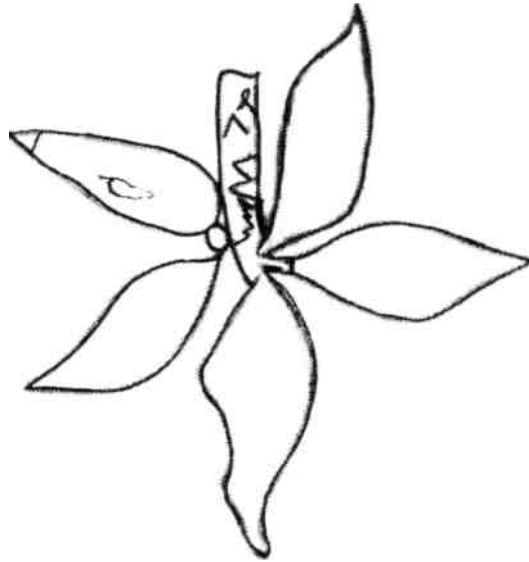

Abito waturu pira.

J

i

pira

mani

Etimohyrjyň heraǵkap miri harwyj
etirwan iratuset kori.

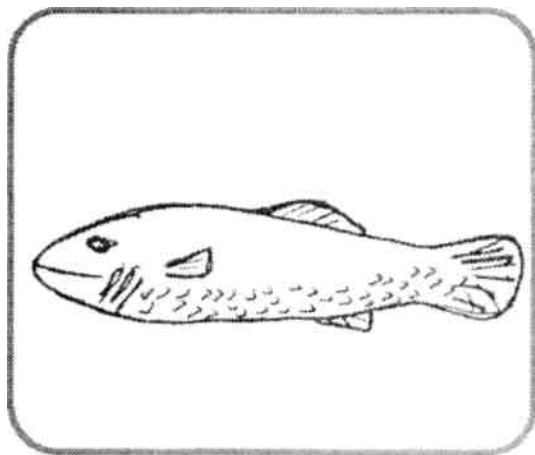

pira
p ra

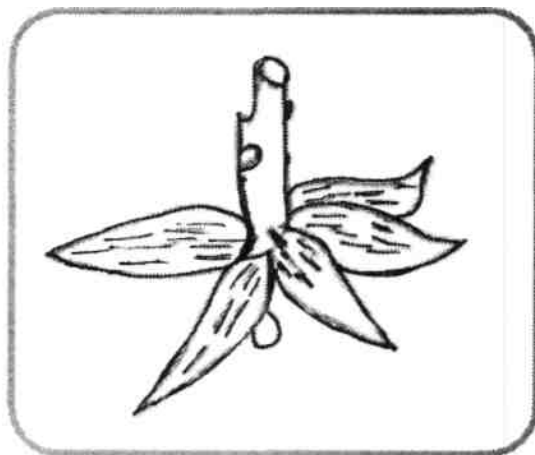

mani
man

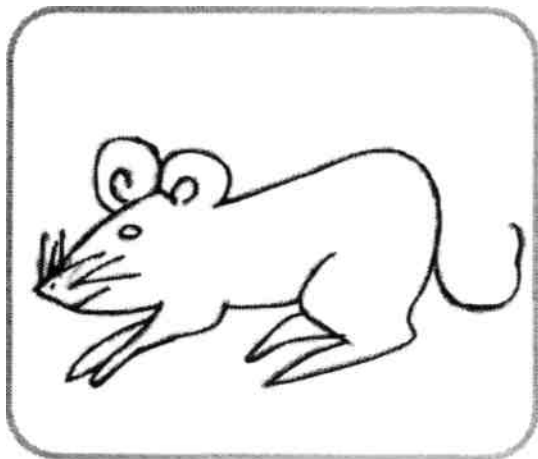

hapiri
hanir

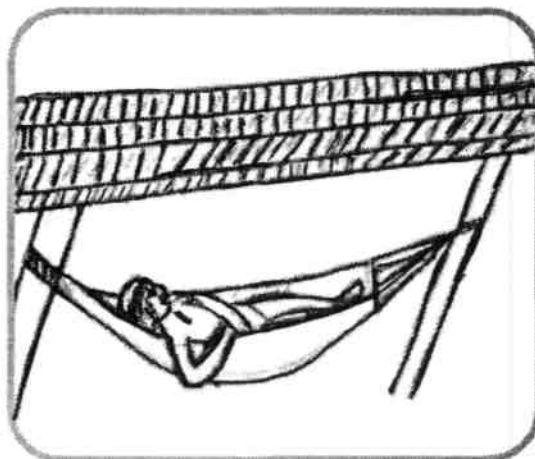

yni
yn

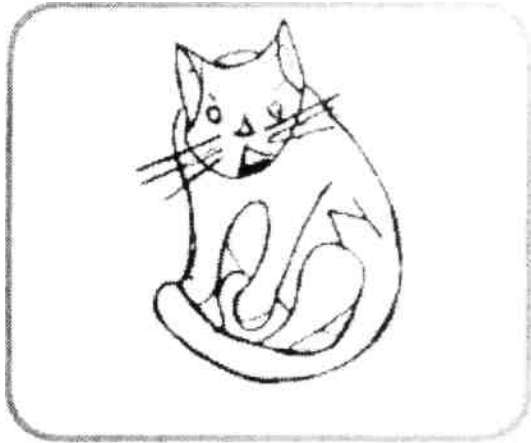

pisana
p sana



wasari
wasa?

Etimoputrok masak piat.

A crossword puzzle grid with the following structure and content:

- A vertical column of 6 cells containing the letters: p, i, s, a, n, a.
- A horizontal row of 4 cells starting with the letter 'a' in the first cell.
- Other cells in the grid are empty.

Illustrations around the grid include:

- A mouse pointing to the first cell of the horizontal row.
- A woven basket pointing to the second cell of the horizontal row.
- A fish pointing to the third cell of the horizontal row.
- A dog's head pointing to the first cell of the horizontal row.
- A parrot pointing to the fourth cell of the horizontal row.
- A turkey pointing to the first cell of a vertical row below the horizontal row.
- A small cat icon circled at the top center.

Etimohyrj, etimowepāp miʻi haruji
etirwan.



Anware toket.

Hirokat yni pe.

Pisana turu hapiri.

Netap ipakup.

Etimoheyrjyp mi:ri harwji etirwan
het kori.

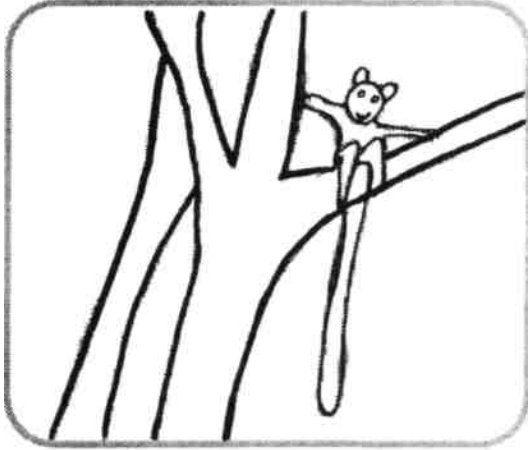

hamiri
ham ?

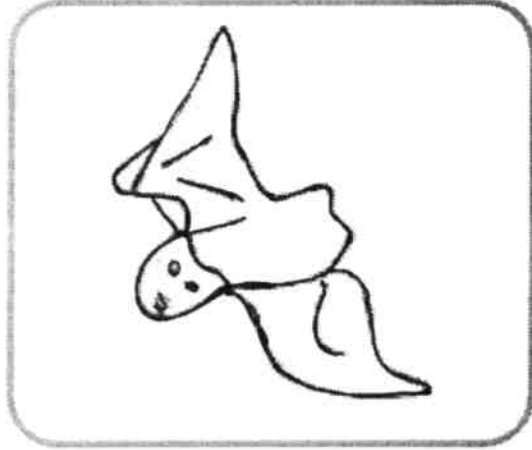

hakiri
hak ?

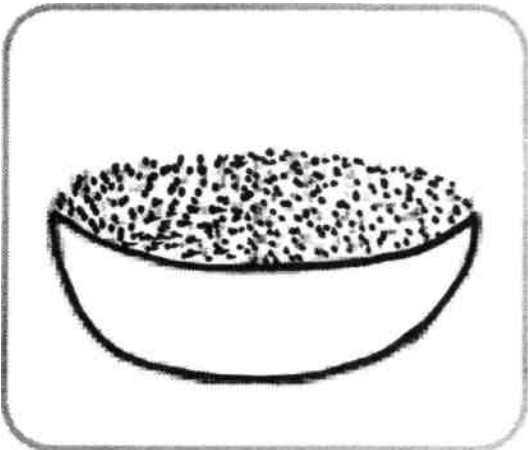

uri
u ?



akuri
akur

Etowan torowatri torowatri miri te
atumuḡ ere.

hamiri							
hakiiri							
uri							

Etirywūt sehary kori torerowwi.

pisana

hamiri

hapiri

hakiiri

yni

uri

yni

uri

pisana

hamiri

hakiiri

hapiri

Etimohyr̄p̄ri pira turweʻarwy ruat.

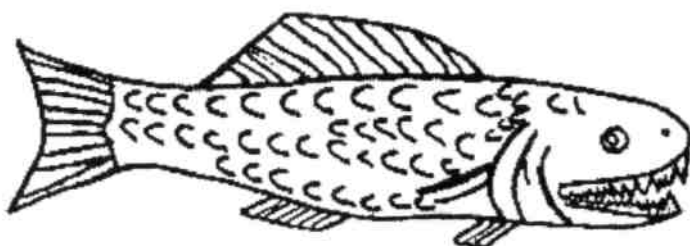
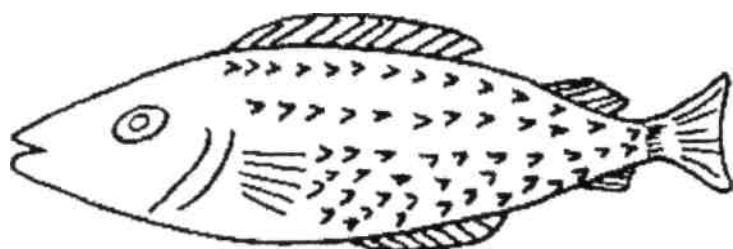
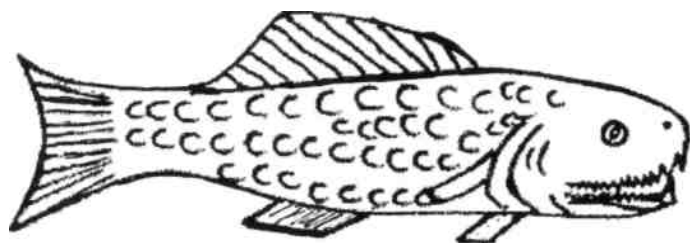

Etimowaku hanuʻan.



Etimoputrok irywt upi sehay nuġ
karia.

A

a

ē

e

ĭ

i

Etimowepār miri harvyi ehe'aġkapsat.

1. Akuri ġarapy pe.

ytr̄y
y

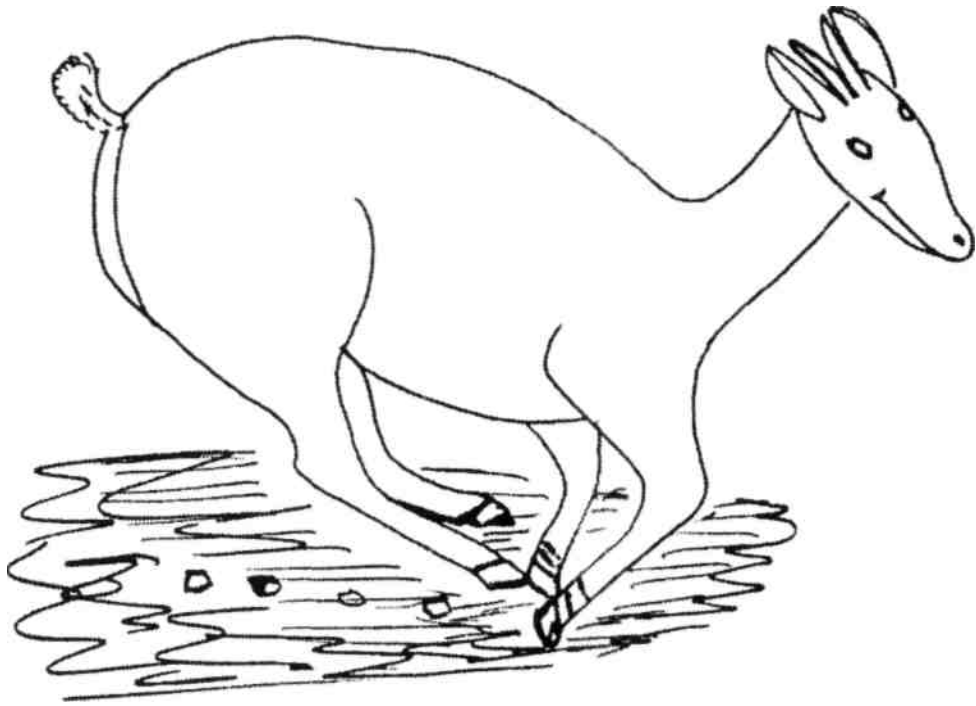

Ytr̄y turu mani yhop.

Y

y

ytr̄y

yni

Etimohyrjyp misi karvyi etirwan
sehary.

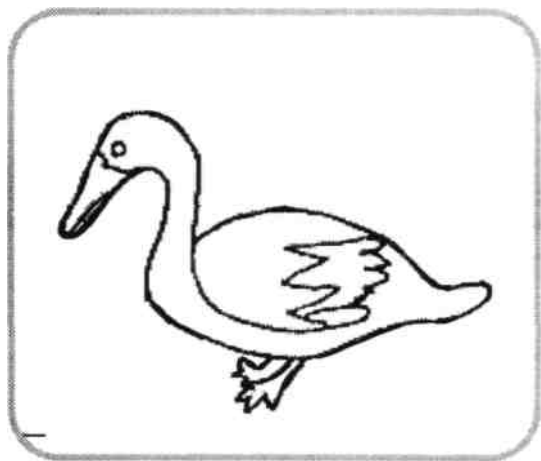

ypaka
peka

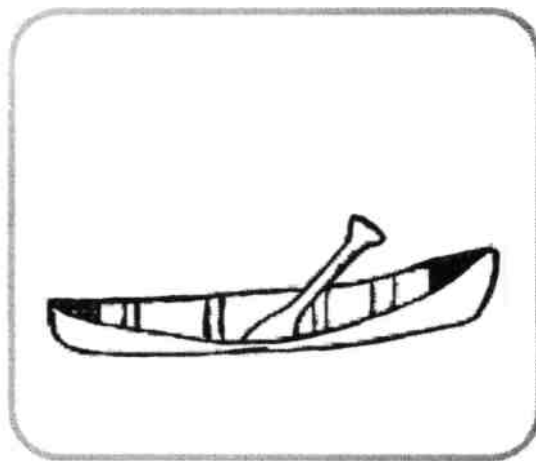

yara
ara



awryky
aw k

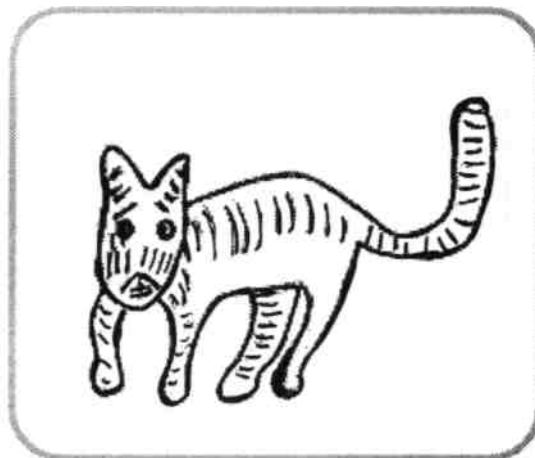

awryato
aw ato

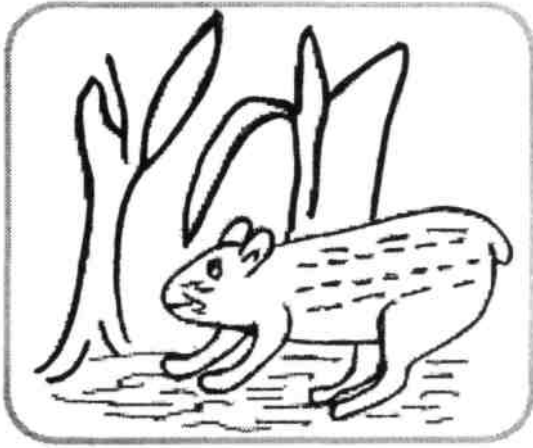

par
pa

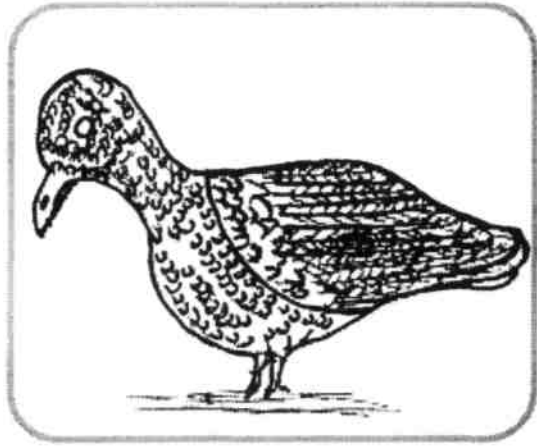

myryhu
m r hu

Etiratumuõ sehay-ryry kori sehay kori
nuõ hamo.

y - ry - po = _____
y - pe - ka = _____
a - wy - ky = _____
my - ry - hu = _____
y - tr̄ = _____
y - ni = _____
a - wya - to = _____
y - ry = _____

Etimowepār mi:ri rokinne etirwan.

y:ry wato _____

yara _____

ypeka _____

myryhu _____

awryky _____

awryato _____

Etimowepār mi:ri harwyi ehe:raǵkapnuǵ.

Wentup yara y:ry pe i:erwǵte tyry

ypeka.

mohoro
mo

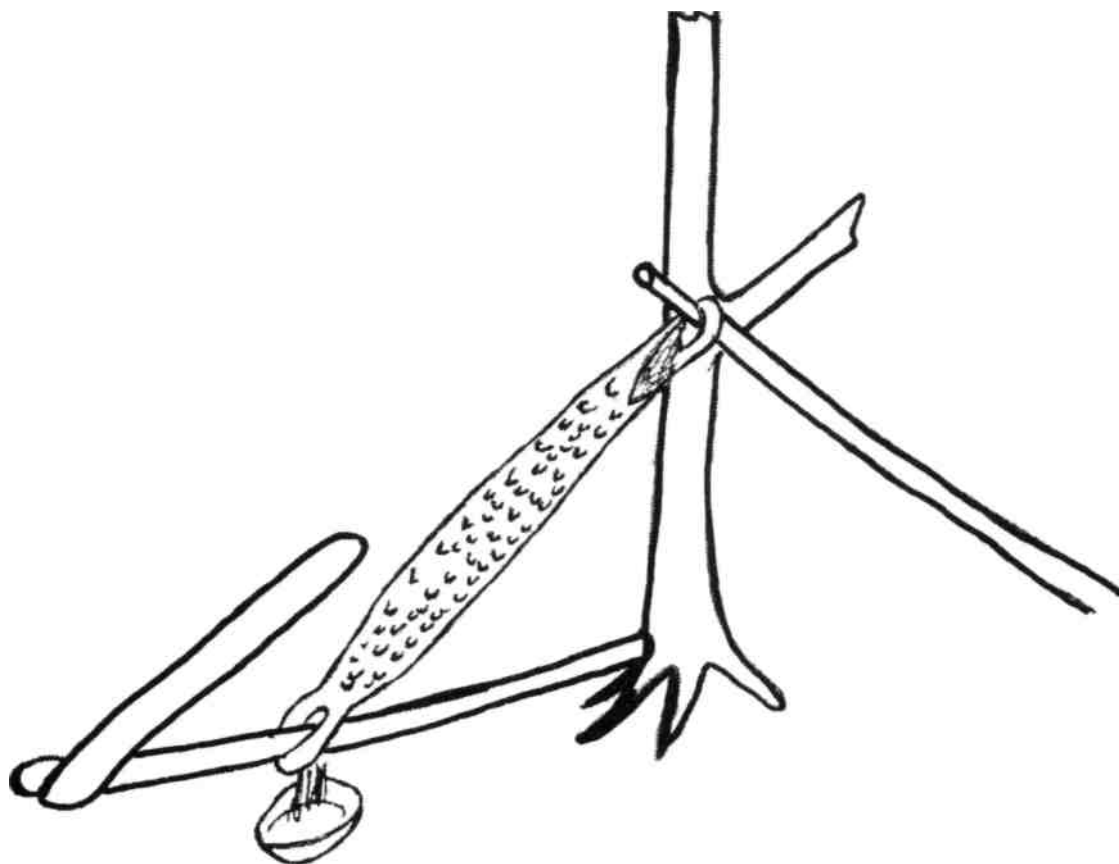

Manekap mohoro pe.

o

o

mohoro

Etimohyrjyr, etimowepāp miʔi haruji
etirwan.

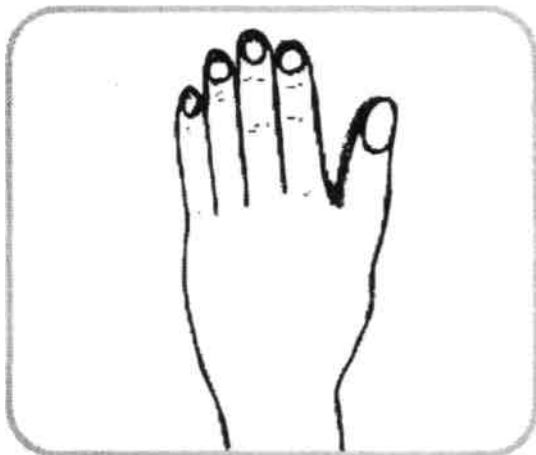

mo

m

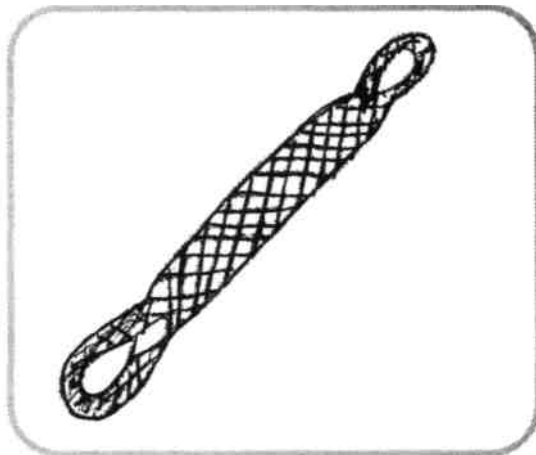

mohoro

moh r

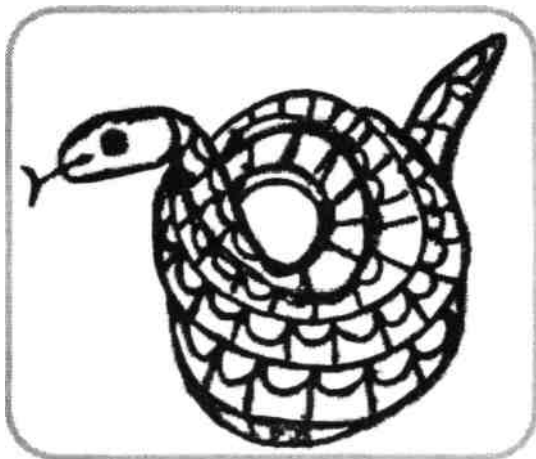

moi

m i

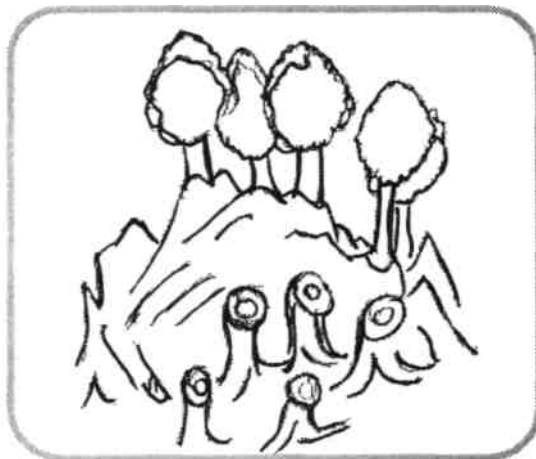

gō

g



soroi

s o r o i

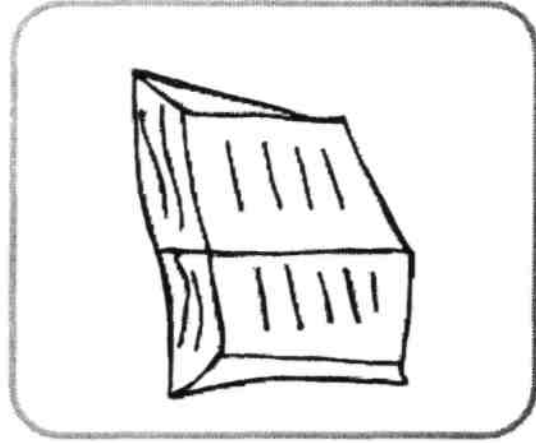

popera

p o p e r a

Etunuḡ sehary kori sehary-ryry kori
urywo.

po	mo	pi
roi	pe	ho
ro	sa	so

Etimohyrjyp he:agkap, etimowepap
misi harwji etirwan.

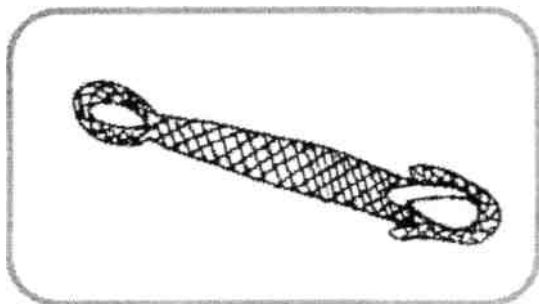

mohoro wato

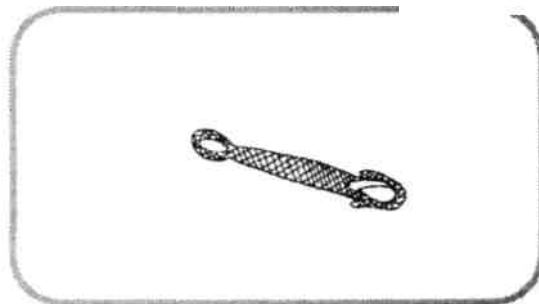

mohoro hit

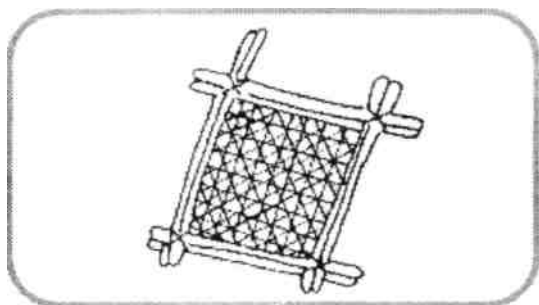

panane wato

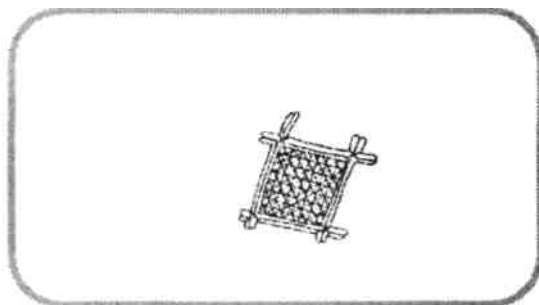

panane hit

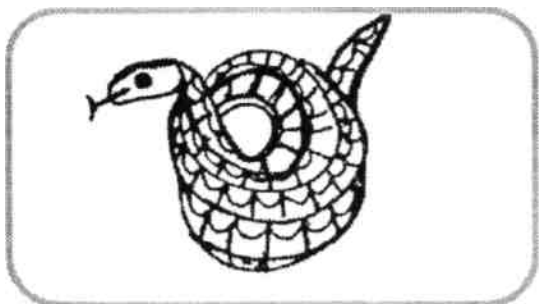

moi wato

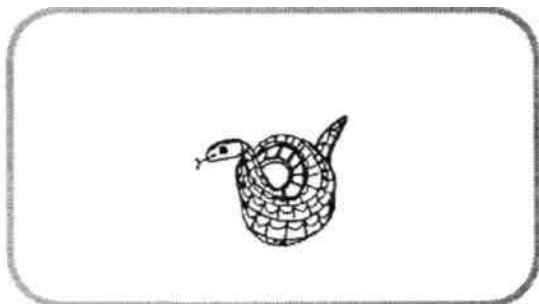

moi hit

Etimovepāp mi'ri karvji ehe'raġkapnuġ.

Yara wato

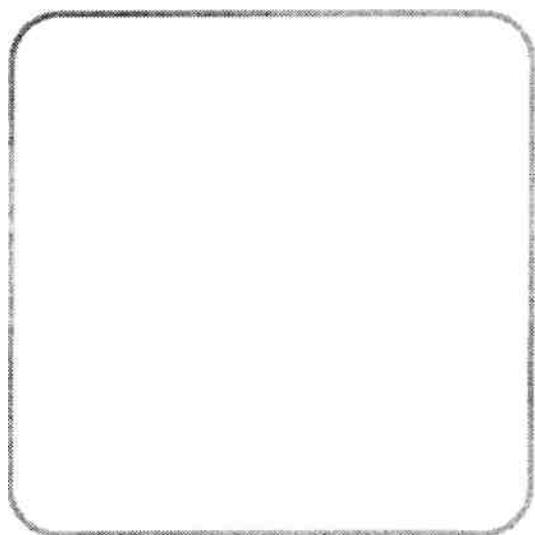

Yara hit

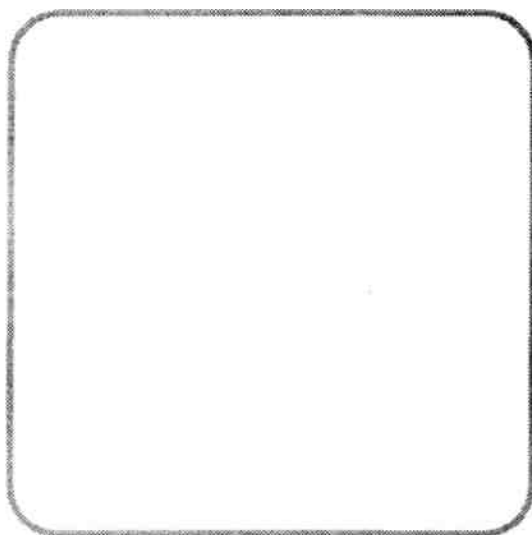

Pira wato

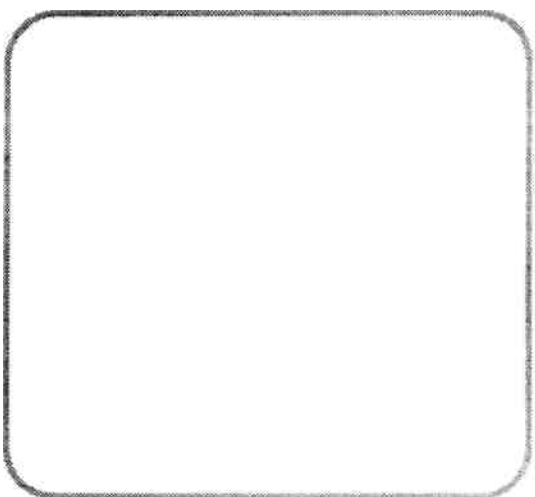

Pira hit

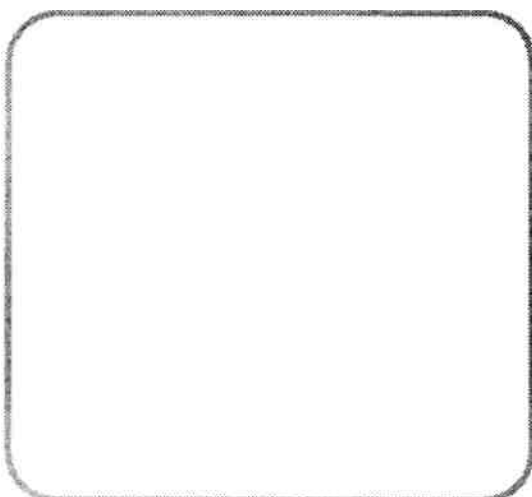

ūre

ū



uri

u

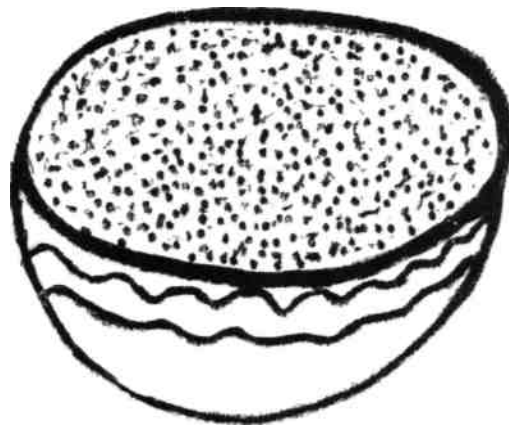

Uito aturu uri.

u

u

uri

ūre

Etimohyrjy, etimowepär miiri haruji
etirwan.

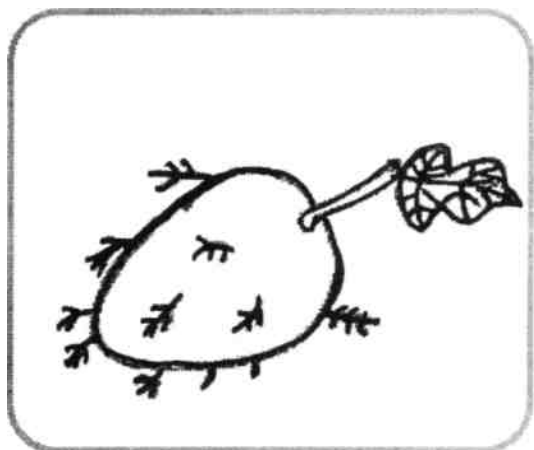

uriuru
ri r

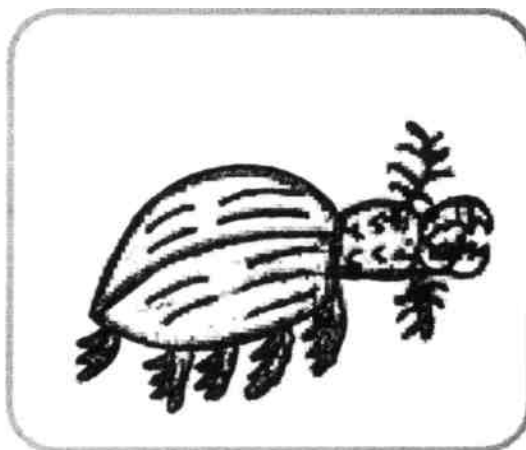

aruru
ar r

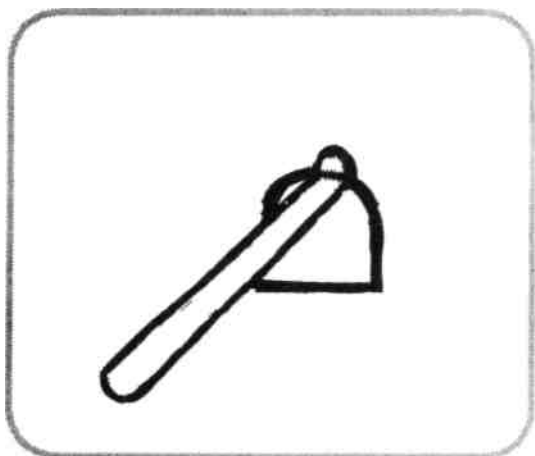

purure
p r r

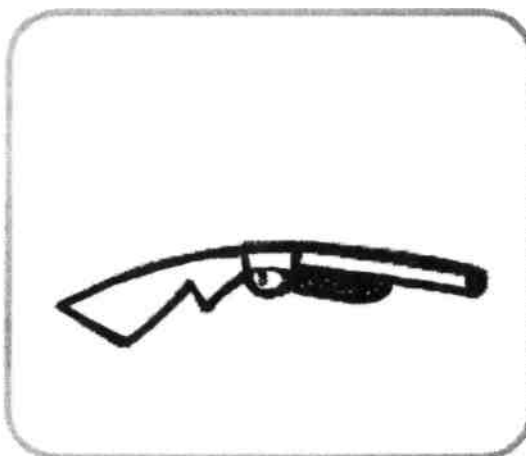

mukā
m kā

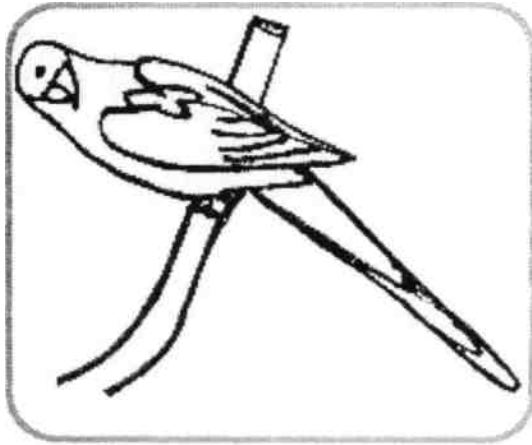

hanūn
han n

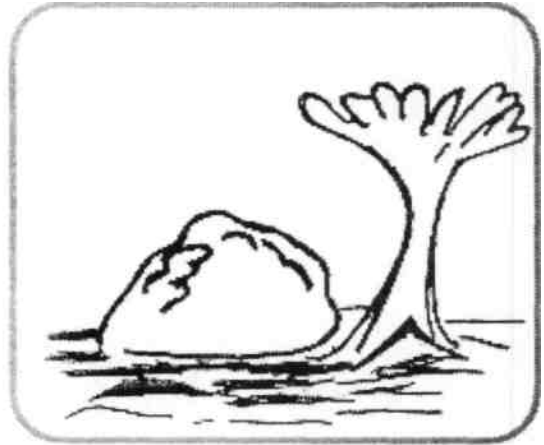

nu
n

Etimpyūt sehay heraǵkap kape.

nu saku
ūku

uriuru

hanūn
aruru

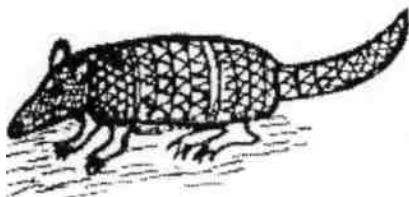

Etiratumuḡ sehary-ypy kori sehary kori
nuḡ hamo.

a - ru - ru = _____

u - ru - ru = _____

ha - nūm = _____

su - hu = _____

ū - hu = _____

pu - ru - re = _____

Etimowepāp miri haruji etirwan.

Uito aturu pira. En eturu pira.

Kurum turu miri puri.

Uruto uruterūt uri epe.

Hirokat turu uri hy.

Kurumirin putrok irature.

Etiryūt sehary heraākap kape.

waipaka

moi

parā

soʻoi

weita



Etiratunuḡ sehary-ypy kori sehary kori
nuḡ hama.

kui - ʻa

= _____

so - ʻoi

= _____

ya - ʻa

= _____

wei - ʻa

= _____

u - riu - ru

= _____

a - wai - ʻa

= _____

wai - pa - ka

= _____

mau - ʻa

= _____

a - wya - to

= _____

a - riu - ke - re

= _____

Etimoputrok sehary kori ai ary au oi wo.

m___	seh___	w___kiru
p___	p___ni	so'___
m___ia	aw___ia	m___ia
w___paka	w___we	s___ru
sah___	mik___	mani'___



Kan hirokaria tunuq erihotrok pe? Eharagkapnuq.

Etirvan veram ruat sehary-ypy nuḡ
kat inyūt upī.

a

e

i

y

o

u

A

E

I

Y

O

U

Arware imiat rakat etiat



Arware toto žarapy kape kurum ryuo.



Miri harvyi toimohan yty.

Miri harvyi
yty arware miat
tarat raryn
ryy pe.

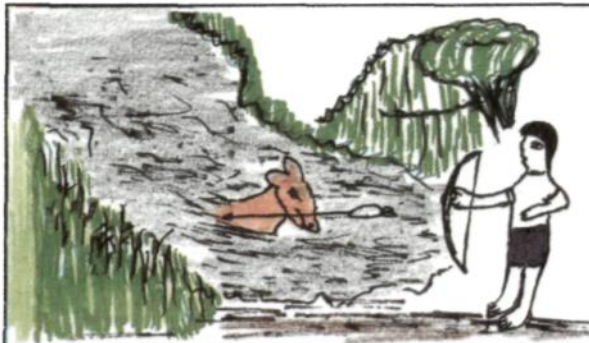
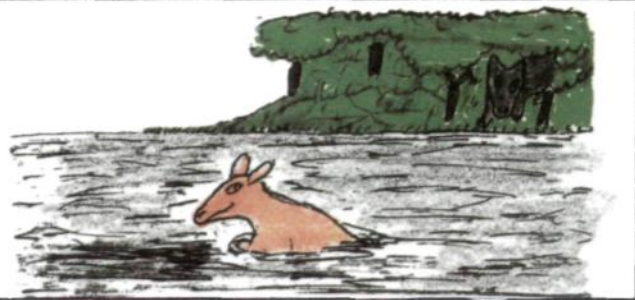

Miri harvyi kurum
tiarwa morya wo
keturusa tote yty.

Etirweesat aporehap kori.

1. Urweiğ toto arware wrywo miat pe?
() Aseri toto. () Kurum toto.
2. Kat wrywoiğ kurum toto miat pe?
() arware wrywo () mukā wrywo
3. Kat peiğ kurum toto arware wrywo?
() wrywo pe () miat pe
4. Kan miri haruji arware timohan?
() ytr̄ () akuri

Etimoputrok sehary-ywop kori.

1. _____ toto ġarapry kape _____ wrywo.
2. Miri haruji arware timohan _____.
3. Miri haruji _____ arware miat tarat rar̄yn _____ pe.
4. Miri haruji _____ tir̄arwa _____ wo heturuwa tote _____.

paname

pa

p

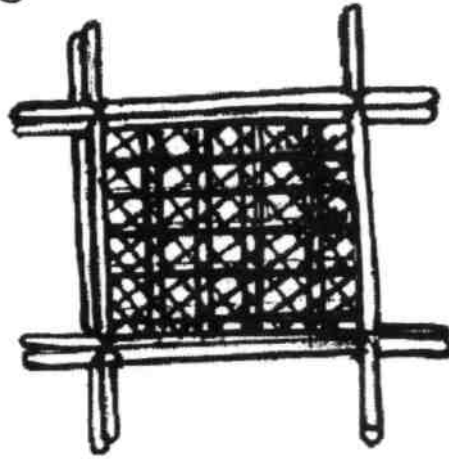

pira

pi

p

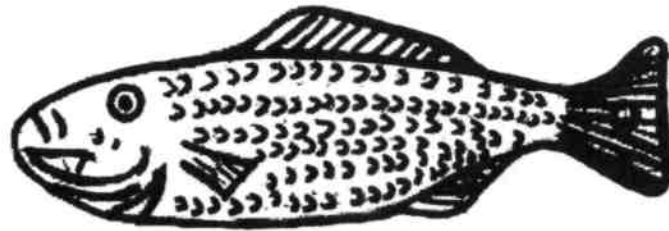

Pira pyre.

P

p

paname

pira

Toʻlowatʻi toʻlowatʻi etunuḡ sehay ypy koʻzi miʻzi
hawyi etiʻatunuḡ hupitʻi teʻzi.

paname = _____ = _____
pira = _____ = _____
popera = _____ = _____
purure = _____ = _____
pisana = _____ = _____

Etimoputʻok sehay koʻzi iʻypy koʻzi wo.

pa	pe	pi	py	po	pu
----	----	----	----	----	----

ati _____

_____rure

_____ra

_____name

a_____keh

y_____ka

_____sama

sok_____

_____pera

a_____kuita

Etiʔywīt miʔi hawyi etiwan heʔaǵkap set.

ǵyp ariaʔyp ǵāp iʔyhop netap

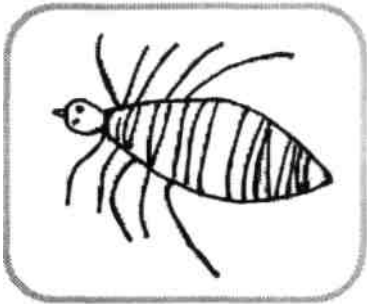
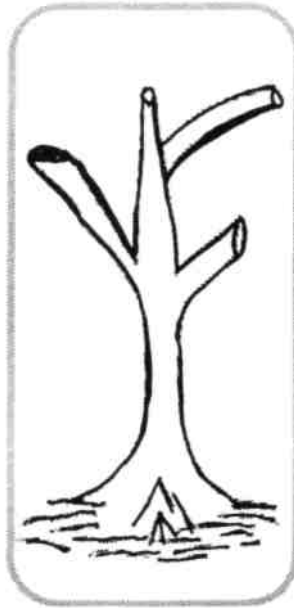

Etimowepāp miʔi hawyi eheʔaǵkapnuǵ.

1. Wahi ikahu kahato.

2. Weita pakpak

Etimoputok sehay nuḡ hap koḡi meimewat
heḡaḡkap koḡi set no.

Ypeka

Pisana

panane

Pira



_____ hekatup hapiri.



Atumuḡ _____.



_____ yempeke.



_____ heruyry yry pe.

Etimoputok sehay koʻi wentup **p** wo miʻi hawyi
etiwan miʻiywīt upī.

___ isana	= _____
___ urure	= _____
neta ___	= _____
___ ira	= _____
a ___ ekek	= _____
gā ___	= _____
ariaʻy ___	= _____
gry ___	= _____
amya ___	= _____
aruyato hu ___	= _____
sok ___ e	= _____

Koitywy etiporokpun sehay koʻi **p** ikahuro rakaria
panar

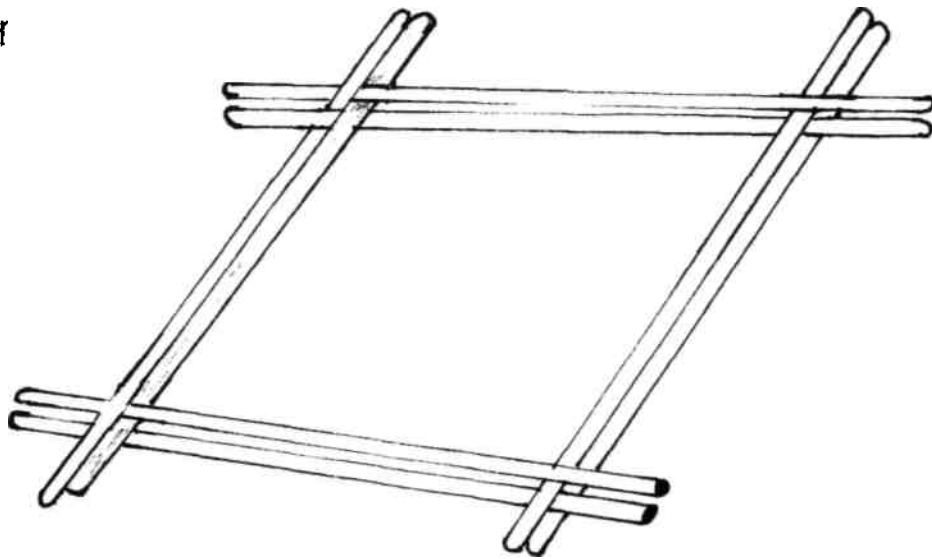

kamuti

ka

k



Kamuti horopy yry wo.

kryse

kry

k



Kryse ipakup.

K

k

kamuti

kryse

kui'a

To?owat?i to?owat?i etunuḡ sehay-ypy ko?i mi?i hawyi eti?atunuḡ hupīt te?i.

krywa	= ___ - ___	= _____
kryse	= ___ - ___	= _____
kumana	= ___ - ___ - ___	= _____
haki?i	= ___ - ___ - ___	= _____
kurum	= ___ - ___	= _____
kryha	= ___ - ___	= _____
suki	= ___ - ___	= _____

Etimoput?ok sehay ko?i i?ypy ko?i wo.

ka	ke	ki	kry	ko	ku
----	----	----	-----	----	----

muḡ ___ rite	___ rum
mo ___ sek?a	___ se?yp
___ wa	ha ___ ?i
___ maru	yp?e ___
___ muti	___ ha
i ___	po ___

Etiporokpun sehay koʻi iʻypy rakaria saʻawyʻi te
wuat maiʻa pe miʻi hawyi ikahuro **k** rakaria
typuatʻi pe.

kryse ihotʻok kurimen apekhek
weita pakpak kuiʻa kryha

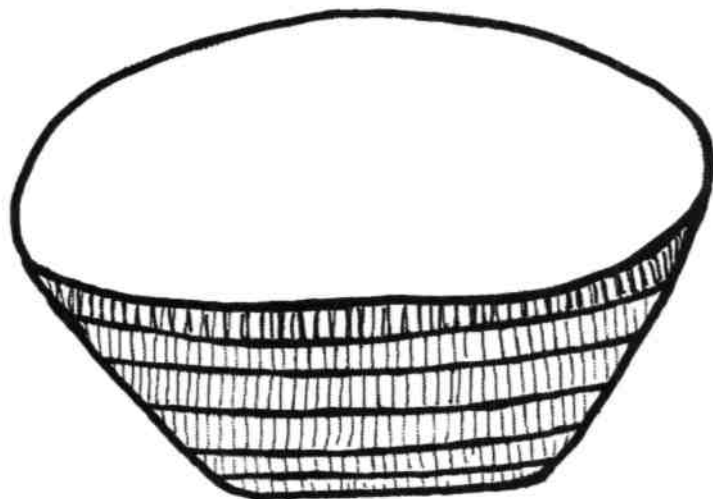
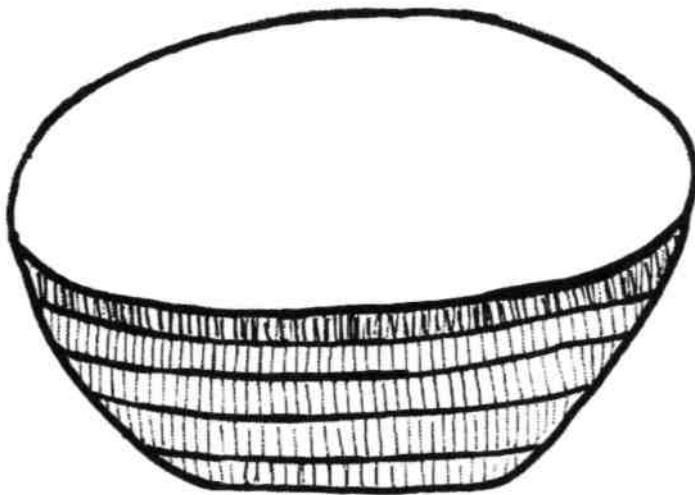

tarwara

ta

t

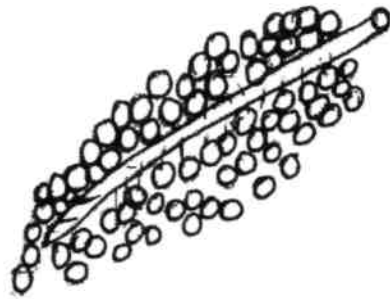

Tarwara irapohup.

tarwa

ta

t



Uito areimeren tarwa pe.

t

t

tarwara

turisā

tapryryia

Etiʔatunuḡ sehay-ypy koʔi sehay koʔi nuḡ hamo.

ta - wa = _____
ta - wa - ra = _____
tu - ri - sā = _____
ā - ti - py = _____
we - wa - to = _____
ne - tap = _____
wa - ty = _____

Etimoputʔok sehay koʔi iʔypy koʔi wo.

ta	te	ti	ty	to	tu
----	----	----	----	----	----

sa _____ re

arɣya _____

wei _____

_____ wara

_____ pyʔɣia

_____ wa

muḡkiʔi _____

_____ ʔisā

kamu _____

ā _____ py

wewa _____

wa _____

Etimohyr̄p heʔaḡkap iwato rakat ihup takat no miʔi
hawyi haʔaḡkap kurin nakat ihyr̄p takat no.

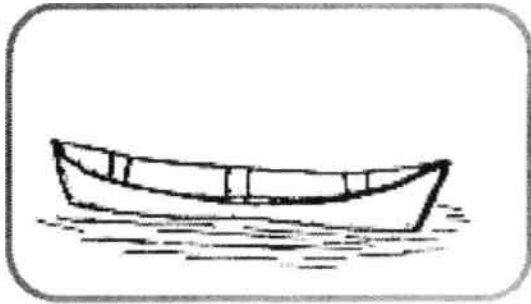

yara wato

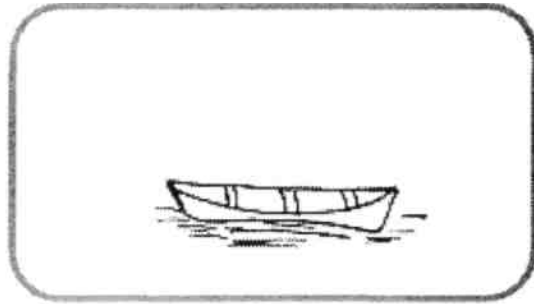

yara hīt

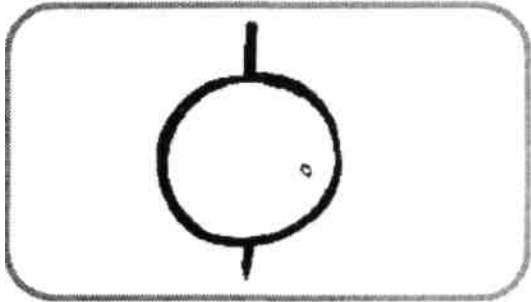

manʔyire wato

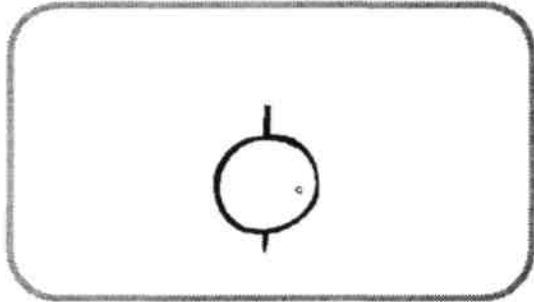

manʔyire hīt

Etimowekuap mitiḡtiḡ upī.



Pirewanwori heruʔyry.

Etimoput^{ok} sehay ko^{ri} wentup **t** wo mi^{ri} hawyi
etiwan mi^{ri}ywīt upī.

pohi _____ = _____
hiroka _____ = _____
iho _____ ok _____ = _____
ā _____ = _____
heika^{ra} _____ = _____
mii _____ = _____
h^y _____ ri _____ = _____

Etiwan sehay nu^g hap ko^{ri} ywaikawiat sehay
wywo.

mani
ma
m



mi'u
mi
m



mory'a
mo
m



Miri maura monto.

M

m

mani

Toʻowatʻi toʻowatʻi etunuḡ sehay-ypy koʻi miʻi
hawyi etiʻatunuḡ hupīt teʻi.

mohoro _____

mani _____

moreperi _____

myrawe _____

miʻu _____

muʻap _____

muse _____

Etimowepāp miʻi hawyi eheʻaḡkapnuḡ.

1. Wentup morya

2. Tyry moreperi

3. Myeʻym weita

Etimowepāp sehay nuḡ hap koʔi miʔi hawyi
etiwan.

Uito atum pira hirokat pe.

Uity tikoi mani.

Abseri Kuru tum miat.

En etikoi mani.

Hirokat toto miat pe.

Etiwan sehay nuḡ hap koʔi sehay koʔi yikawiat
wywo.

myryhu

morya

kurum

moi

miʔu

Etikāt sehay koʻi.

moryʻa miʻu kurum
mani muʻap myryhu

m	k	u	r	u	m	s	t
o	y	n	m	a	n	i	r
m	i	ʻ	u	n	k	o	h
ʻ	w	m	y	r	y	h	u
m	o	r	y	ʻ	a	ḡ	t
h	n	m	u	ʻ	a	p	h

Etimowepāp miʻi hawyi eheʻaḡkapnuḡ.

ʻKurum jaʻampe wywo.

nana

na

n

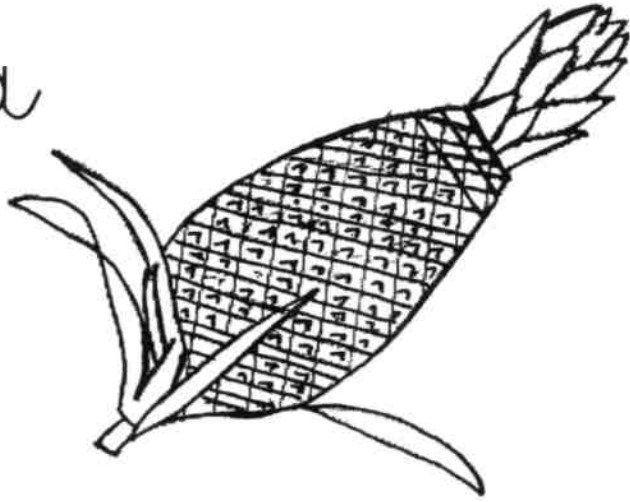

Nana hē kahato.

nu

n



Nu iwato kahato.

N^p

n

nana

nu

hanūn

Etimowepāp sehay nuḡ hap koʔi miʔi hawyi
etiwan.

Netap ipakup.

Pahai toimeren yi pe.

Miri ipun nu yʔy pe.

Uito min are.

Abito watumuḡ aiko.

Uruto urutenuk taʔyn.

Miri inuḡ aria.

Warana waku.

Ehenoi sehay potʔi warana etiat miʔi hawyi
ehentup hirokaria piat heʔaḡkap nuḡ hamo.

Etimoputok sehay koʻi wentup n wo.

araka _____

ma _____

we _____ tup

hanū _____

juḡka _____

y _____ i

iʻama _____

ma _____ i

wa _____ tym

kurime _____

na _____ a

_____ u

hanuʻa _____

pana _____ e

wara _____ a



Juḡkan ihay "en en en" ʻe
wasari wuat toʻok harwi
iʻaman toikarykay,
tuweʻyʻutui kahato
wasari wuat toʻok
kahato harpe.

Etimoputʔok sehay koʔi iʔypy koʔi wo.

ma	me	mi	my	mo	mu
----	----	----	----	----	----

_____ ni	_____ re	_____ koi
_____ horo	_____ sē	_____ h̄ȳt
ha _____ i	_____ nahū	_____ kā

na	ne	ni	ny	no	nu
----	----	----	----	----	----

ma _____	na _____	y _____
_____ mo	pi _____	mani _____
wara _____	ma _____ ay	pa _____ ne

Etipuenti sehay koʔi.

mani	moh̄ȳt	menahū	hamiʔi
nana	warana	yni	maninu

p	k	m	o	h	̄ȳ	t	s	w	n	a	n	a
m	c	n	a	h	ū	i	j	r	p	n	y	h
ḡ	k	y	n	i	t	r	a	m	a	n	i	w
w	a	r	a	n	a	p	h	a	m	i	ʔ	i
y	s	m	a	n	i	n	u	k	ḡ	e	s	t

gāraņņ

gā

g



gō

g

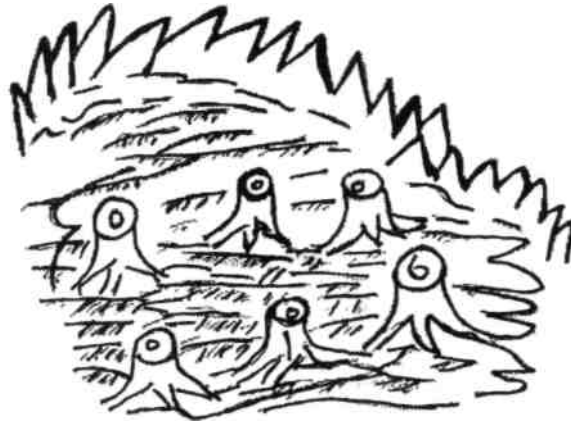

Gō gāraņņ pe.

g

g

gō

gāraņņ

gāņ

gņņ

Etimopotok sehay koʻi wentup **g** wo miʻi hawyi
etiwan miʻywīt upī.

ju _____ = _____
ju _____ kan _____ = _____
weʻeho _____ = _____
iʻaka _____ = _____
a _____ kuka _____ i _____ = _____

Etiʻatunuḡ sehay ypy koʻi sehay koʻi nuḡ hamo.

y - ry - sa - kaḡ = _____
ḡa - ra - py = _____
we - ro hoḡ = _____
i ra kaḡ = _____
ḡa rat po = _____
wa - hi - tiḡ - ri = _____
je - hoḡ = _____

Koitywy etiporokpun sehay koʻi **g** ikahuro rakaria
iʻapopyē pe.



Etimoputok sehay nuḡ hap koʔi meimewat heʔaḡkap koʔi set no.

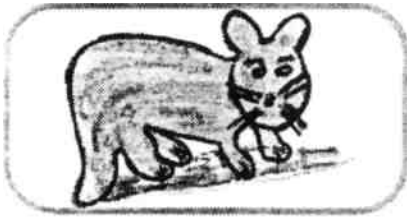

_____ toto pɾya.



Ḳurum tirawa _____.

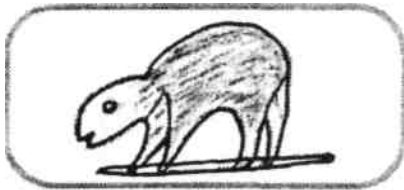

_____ topopɾy pɾya kahato.

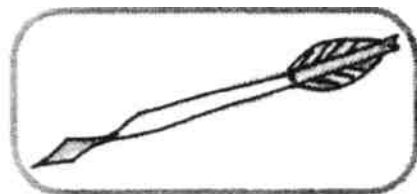

Ḳirokat tunuḡ _____.



_____ mikoi pohɾyt rote.

Ĝarapy karawat Aseri Kuru

Miat karawat toineren Aseri Kuru ĝarapy
pe ypraĝhupe pe iature, inyat ypraĝhupe pe toineren.

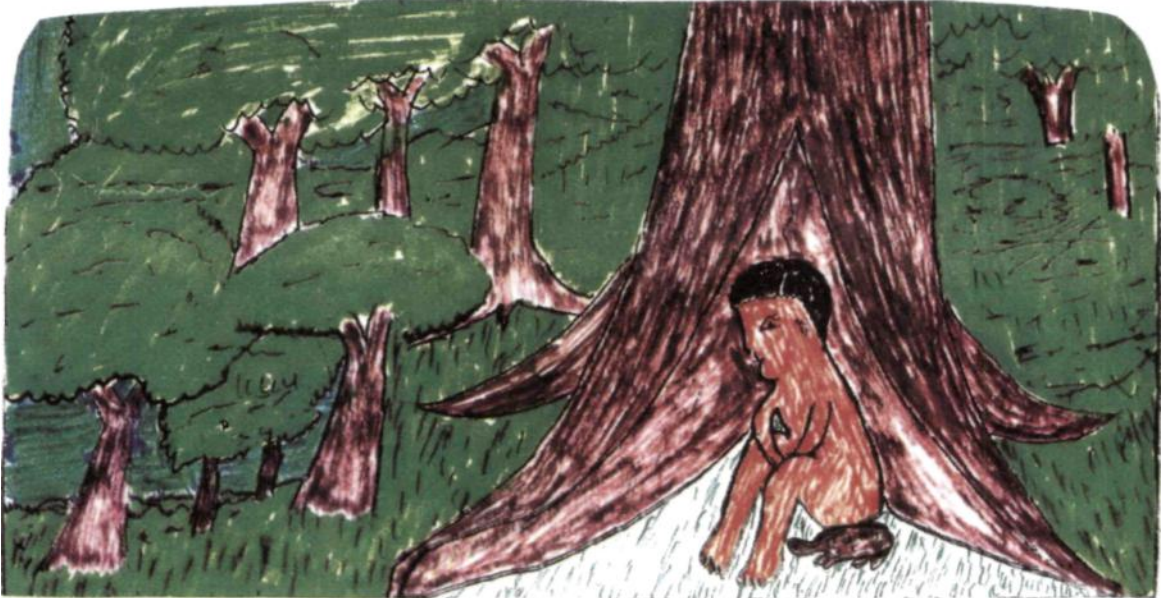

Miri ihay taratuhuap karwyi miat-kāt haria
hentup miat Aseri Kuru pe : atikypesat miat iature.

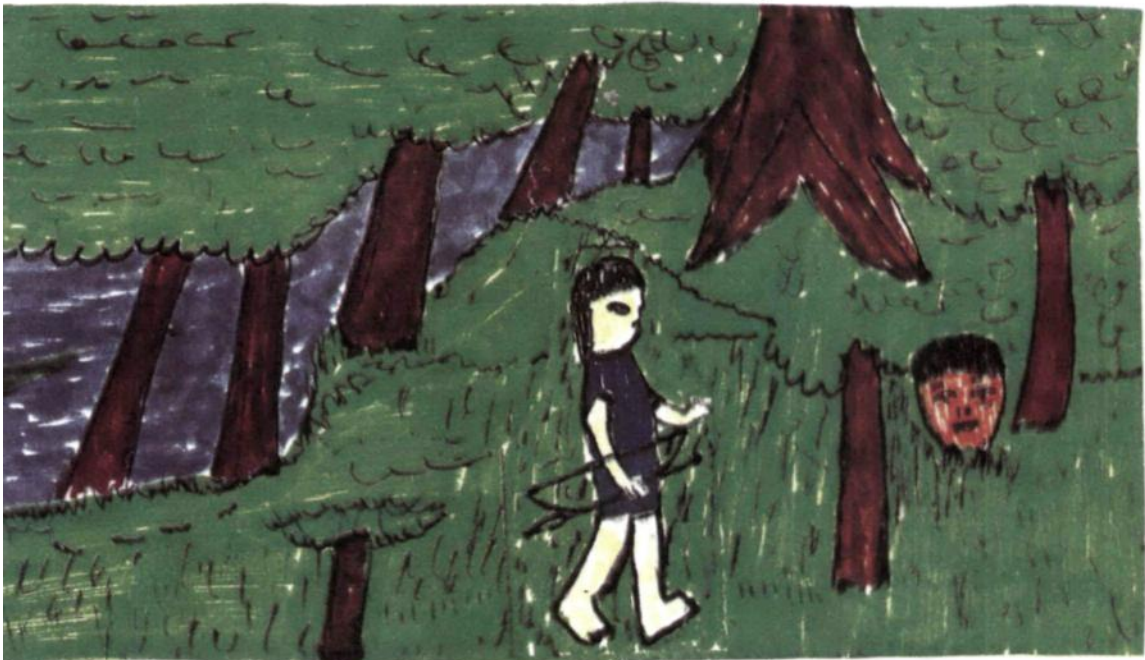

Etiweesat apo?ehap sehay ko?i.

1. Urweiḡ ḡarapy karawat?
 Aseri Kuru
 miat-kāt haria
2. Abijumpeiḡ toimeren Aseri Kuru?
 yry wato pe
 ḡarapy pe
3. Kban miat-kāt haria tikwap?
 Aseri Kuru ehay
 weitaria ehay
4. Kban miat-kāt haria hentup Aseri Kuru pe?
 miat
 yry

Etimoput?ok sehay-ywop ko?i.

1. _____ karawat Aseri Kuru.
2. ḡarapy pe toimeren _____.
3. Aseri Kuru tum _____.
4. Mbiat-kāt haria hentup _____.

warana

wa

w



Warana wape.

wahi

wa

w



Wahi ikahu kahato.

W

w

warana

wahi

waikiru

wero

waraasa

wa

w



Waraasa pesore.

wahue

wa

w

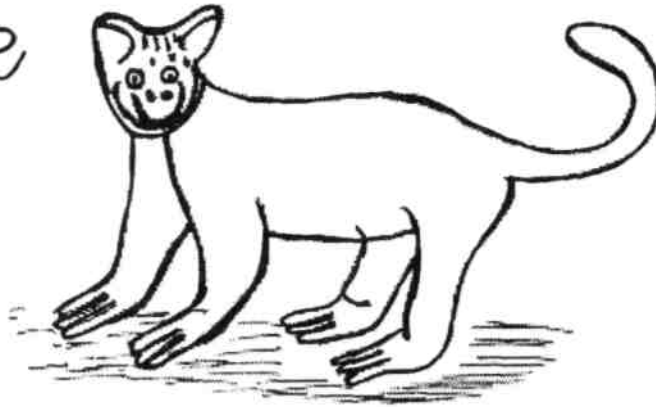

Wahue irwepit.

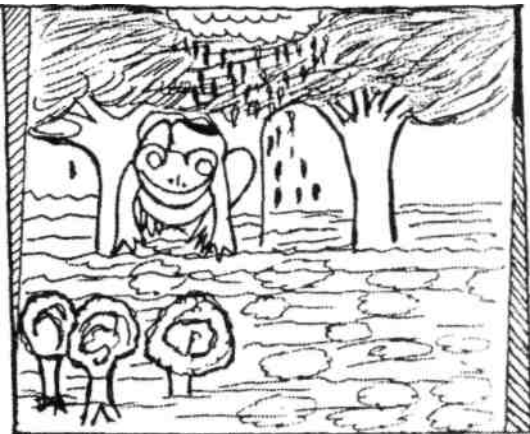

Ihary iraman
pote warasa.

Yiapo pe warasa
iraman kosap we
ihary : we we we...

Toʻowatʻi toʻowatʻi etunug sehay-ypy koʻi miʻi
hawyi etiʻatunuḡ hupīt teʻi.

waʻasa _____

watʻy _____

warwori _____

wewato _____

awʻyky _____

awati _____

waipaka _____

waikiru _____

Etimowepāp miʻi hawyi etiwan.

Miʻi tikʻytrʻt warwori.

Atipy herwaikiru.

Aware ikuʻuro.

Wewato ikʻyt.

Waʻasa ihay : we we we we we we.

Etimoputok sehay kōri iṛypy kōri wo.

wa	we	wi	wy	wo	wu
----	----	----	----	----	----

___ hi

a ___ ky

ky ___

we ___

wai ___

___ asa

a ___ ru

___ kiuri

wa ___ ri

ara ___

ky ___

ure ___

Eheṛaḡkapnuḡ :

1. Awuru

2. Waruri

3. Wakiuri

arwiʔa

ʔa

ʔ

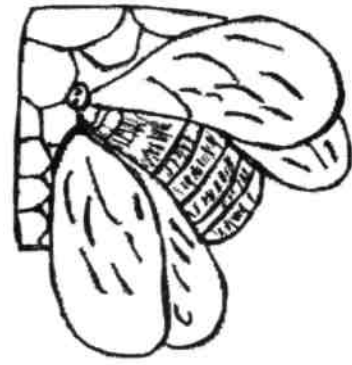

Arwiʔa syt aria tuiu.

hakiʔi

ʔi

ʔ



Hakiʔi hekaturu waipaka.

uri

yʔy

miʔu

arwiʔa

hakiʔi

arwaiʔa

Etimoputʔok sehay koʔi iʔypy koʔi wo.

ʔa	ʔe	ʔi	ʔy	ʔo	ʔu
----	----	----	----	----	----

g̃a _____ py

ase _____

arwi _____

y _____

wasa _____

wa _____ sa

kui _____

haki _____

morepe _____

mory _____

piki _____

waipe _____

Etikāt sehay koʔi.

akuri miat g̃aʔapy pay kuru
 sahu wahue warori yʔaḡkupe yʔr̃

g̃	a	ʔ	a	p	y	m	k	u	r	u
m	p	t	o	w	a	h	u	e	k	n
s	y	p	ʔ	a	g̃	k	u	p	e	t
y	t	ȳ	t	w	g̃	r	p	a	y	s
t	s	y	h	o	w	a	w	o	r	i
j	a	k	u	r	i	h	s	r	i	g̃
m	t	h	s	a	y	j	p	n	o	k
s	a	h	u	k	h	m	i	a	t	k

Etimowepāp, etimohyr̄p miʔi hawyi etiwan.

ʔakiri toket.

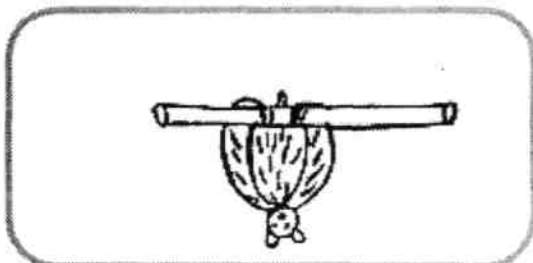

ʔakiri yt toket ri.

ʔyʔri topop̄y.



ʔyʔri yt topop̄y ri.

ʔirokat turu miru puri.

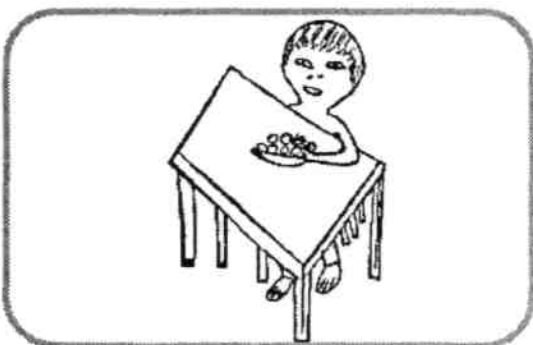

ʔirokat yt turu ri miru puri.

hanūn

ha

h

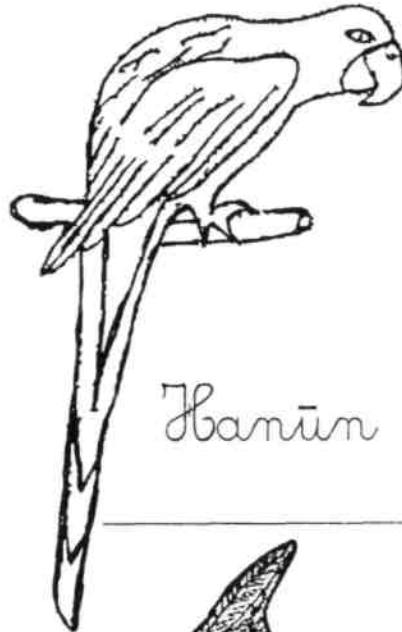

Hanūn teha'āt.

hywi

hy

h



Hywi tāt weita.

H

h

hanūn

hywi

hirokāt

Toʻowatʻi toʻowatʻi etunuḡ sehay-ypy koʻi miʻi
hawyi etiʻatunuḡ hupīt teʻi.

hapiri _____
hirokat _____
hanūn _____
hywi _____
hary _____
haryporia _____

Etimowepāp miʻi hawyi eheʻaḡkapnuḡ.

1. Wentun hanūn.

2. Wentun hanuram.

Hrywi wato etiat

Hrywi wato tēhary
upī toto.



Miri haruji hrywi toto yry kape
terapiririn wrywa.



Mbarato yti turvei teram'ri haruyi
taratusapei-sapei.



Toi ratupeki'ag-peki'ag.



Moheta're
peki'ag-peki'ag
pote ran
mohē aseri
tirauha
orywōt!

sahu

sa

š



Sahu toimeren ģo pāt pe.

so ?oi

so ?

š



Sooi tunuģ tosoh.

š

š

sahu

sooi

sama

sara

Etiwan heʔaḡkap set miʔi hawyi etunuḡ sehay nuḡ hap.

sara sahai sama
soroī suhu



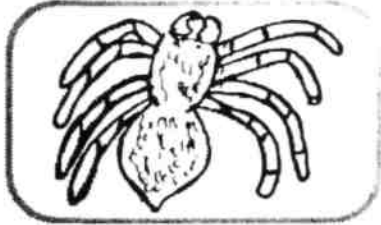

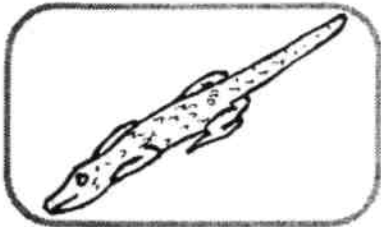





Etimoputok sehay koʻi iʻyry koʻi wo.

ʻa	ʻe	ʻi	ʻy	ʻo	ʻu
----	----	----	----	----	----

wa__sa

mi__

u__

y__

morepe__

hami__

mau__

arwi__

kui__

ha	he	hi	hy	ho	hu
----	----	----	----	----	----

mo__ro

ma__

__nuʻan

__kiri

arwa__ru

__wi

wa__

__piri

sa__

sa	se	si	sy	so	su
----	----	----	----	----	----

pi__na

mu__

__ki

ky__

wa__ʻi

__rit

__ʻoi

__hai

ky__ʻyʻp

yara

ra

~

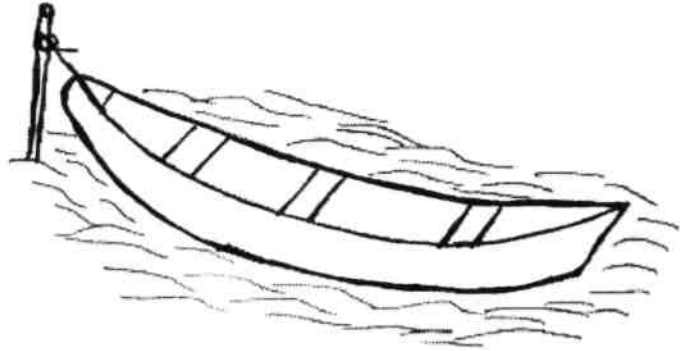

Yara yry pe.

weri

ri

~

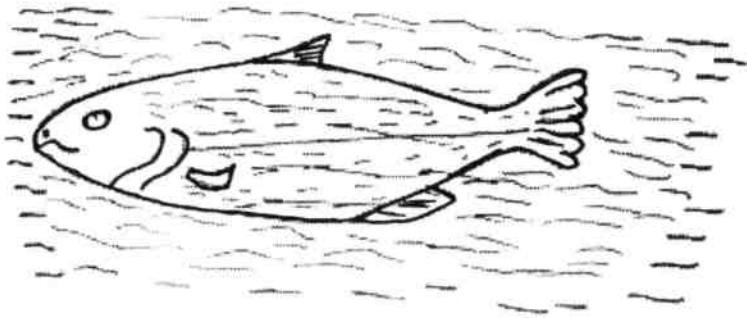

Weri yry pe.

R

~

yara

sara

purure

pirure

Etimoputok sehay kozi i?ypy kozi wo.

ra	re	ri	ry	ro	ru
----	----	----	----	----	----

mo ___ rywat = _____

pi ___ = _____

awa ___ = _____

pi ___ re = _____

my ___ we = _____

ya ___ = _____

hapi ___ = _____

moho ___ = _____

hi ___ kat = _____

ha ___ poria = _____

ariuke ___ = _____

pu ___ re = _____

popo ___ = _____

sa ___ = _____

Hirokat tirawa ariukere.

Etiwan sehay nuḡ hap koʔi sehay
yikawiararia wo.

ariukere _____

aria _____

hary _____

hirokat _____

yara _____

Etimowepāp miʔi hawyi eheʔaḡkapnuḡ.

ʔhirokat toto miat pe.

juḡkan
juḡ
j



Juḡkan ihay.

J

j

juḡkan

juḡ

jaꞑampe

jun

Etimowepāp miʔi hawyi etiwan.

Ḳurum jaʔampe wɣwɔ tehairu hams.

Ukɣtʔi tɣarwa juḡkam hemuk turam.

Uwɣwɔt terūt juʔi ḡaʔapɣ kairɣi.

Aware-ɣɣ pe juḡ kɣpɣa.

Etunuḡ heʔaḡkap koʔi.

juḡ

juʔi

jaʔampe

Three empty rounded rectangular boxes are provided for handwriting practice, corresponding to the words 'juḡ', 'juʔi', and 'jaʔampe' written above them.

Etimowepāp miʻi hawyi etiwan.

Koityry en irarʻyn eremūʻe.

Koityʻi kurum toto miat pe
turwemūʻe harʻyi.

Mbuḡkiʻite hūnete aito waturwat
kempy pe.

ḡaratpo hirokat toty rywo ipotʻām.

Etiweesat.

1. Koityʻi kat eturu?

2. Koityʻi apo en ererwei rarʻyn?

3. Koityʻi apo en ereto pira pe?

4. Kat etumuḡ ḡaratpo?

Sehay nuḡ haria.

a	A	A	a
aware	Aware	Aware	Aware

e	E	e	E
erat	Erat	eʔat	Eʔat

i	I	i	I
iko	Iko	iko	Iko

y	Y	y	Y
ypeka	Ypeka	ypeka	Ypeka

o	O	o	O
oken-ypy	Oken-ypy	oken-ypy	Oken-ypy

u	U	u	U
uriuru	Uriuru	uriuru	Uriuru

Sehay nuĩ hat powyro hap.

h	ℋ	h	H
j	J	j	J
m	M	m	M
n	N	n	N
g̃	G̃	g̃	G̃
p	P	p	P
k	K	k	K
r	R	r	R
s	S	s	S
t	T	t	T
w	W	w	W
?		? ,	

PYNO HARYPORIA TOINE'EN MIAT-KÀT HAT



He'agkapsat haria:

Daniilson Oliveira — Dinoel Ribeiro

Ednelson Cristino — Gelson da Silva Oliveira

Inácio Cristino da silva

Jordilei Ferreira dos Santos — Sidney Micheles

Euzébio José Torquato Miwan

Jovina minug sehay

Karampe totó
miat pe
ta'awareria
wywo,

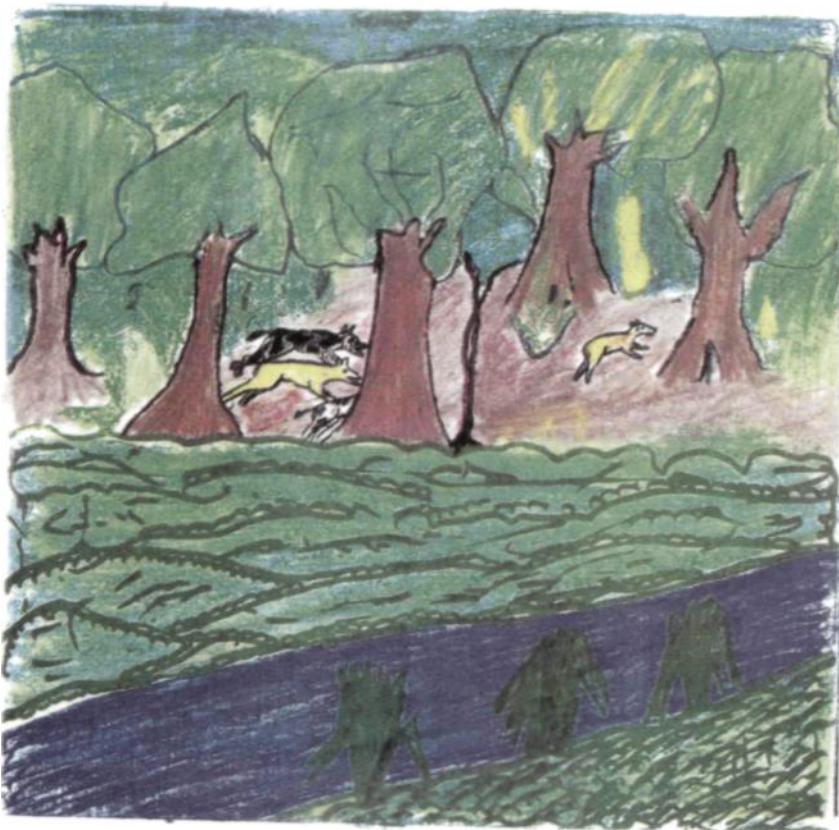
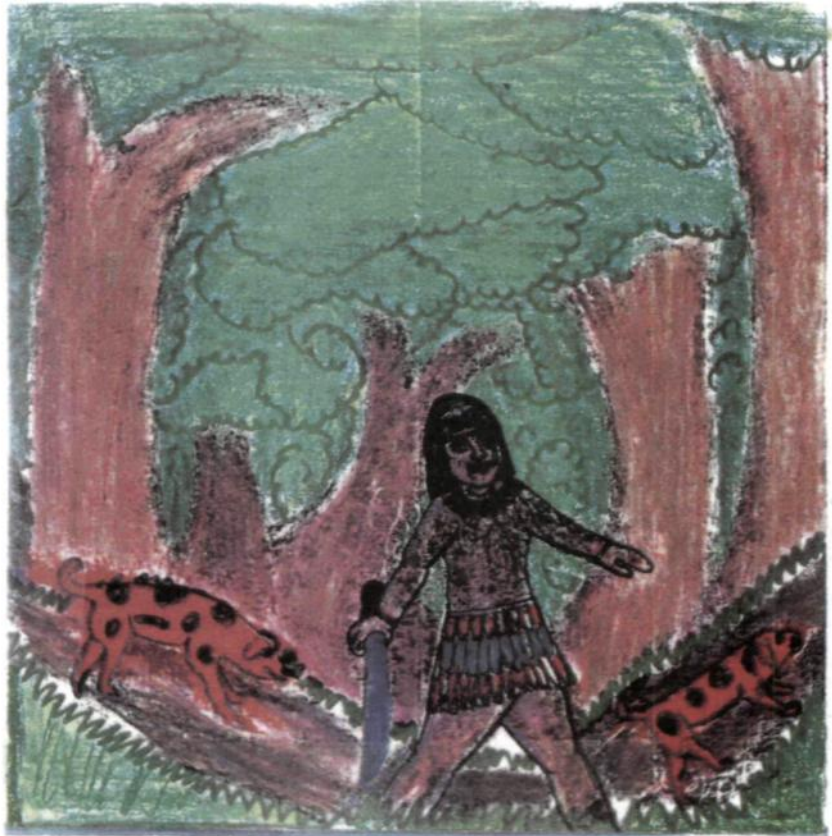

mi'i hawyi
he'awareria
timohan akuri,

hawyi
ta'atuporerek
e aria'yp we.



90

Hawyi
toi'okhot aria'yp
akuri'auka hamo
hawyi toi'auka.

Mi'i hawyi
he'aware
tipuenti
wawori,

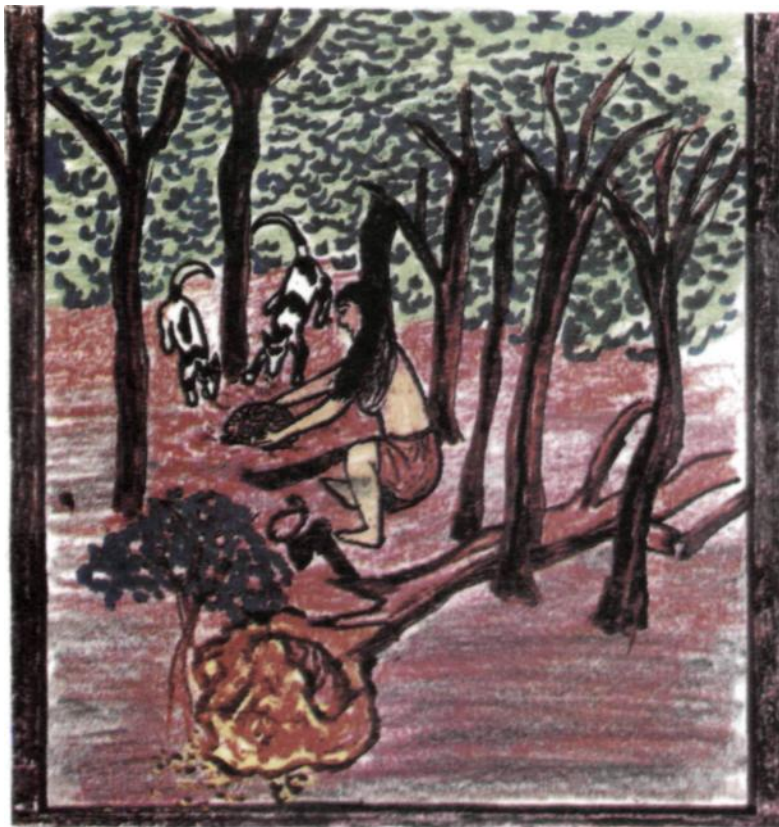
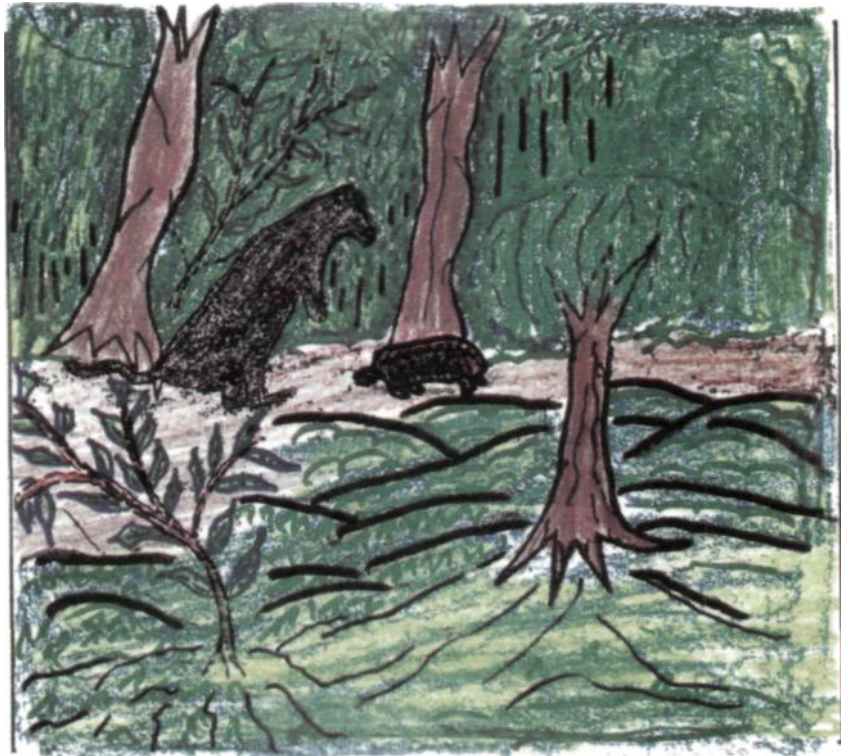

hawyi
he'aware
tihau-hau
hawyi
totaat.

I'ewyte
he'aware
hepay rakat
hawyi pay
aware tipuenti.

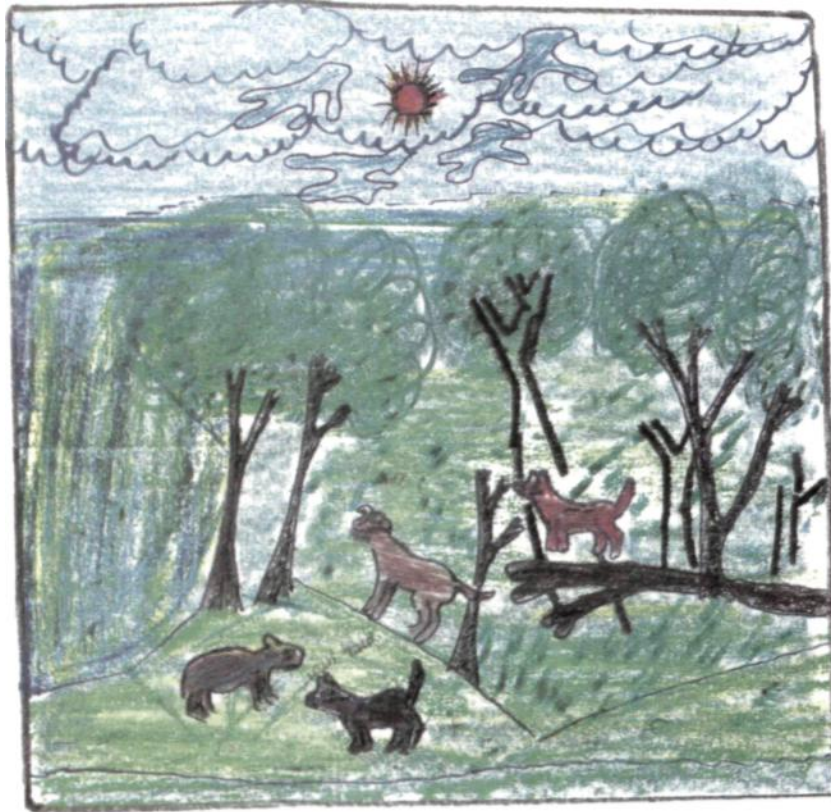

Mi'i hawyi
toi'auka pay.

Imiat rakaria ta'awareria
wywo totó hawyi, toterut pay,
akuri, wawori.



Livros Grátis

(<http://www.livrosgratis.com.br>)

Milhares de Livros para Download:

[Baixar livros de Administração](#)

[Baixar livros de Agronomia](#)

[Baixar livros de Arquitetura](#)

[Baixar livros de Artes](#)

[Baixar livros de Astronomia](#)

[Baixar livros de Biologia Geral](#)

[Baixar livros de Ciência da Computação](#)

[Baixar livros de Ciência da Informação](#)

[Baixar livros de Ciência Política](#)

[Baixar livros de Ciências da Saúde](#)

[Baixar livros de Comunicação](#)

[Baixar livros do Conselho Nacional de Educação - CNE](#)

[Baixar livros de Defesa civil](#)

[Baixar livros de Direito](#)

[Baixar livros de Direitos humanos](#)

[Baixar livros de Economia](#)

[Baixar livros de Economia Doméstica](#)

[Baixar livros de Educação](#)

[Baixar livros de Educação - Trânsito](#)

[Baixar livros de Educação Física](#)

[Baixar livros de Engenharia Aeroespacial](#)

[Baixar livros de Farmácia](#)

[Baixar livros de Filosofia](#)

[Baixar livros de Física](#)

[Baixar livros de Geociências](#)

[Baixar livros de Geografia](#)

[Baixar livros de História](#)

[Baixar livros de Línguas](#)

[Baixar livros de Literatura](#)
[Baixar livros de Literatura de Cordel](#)
[Baixar livros de Literatura Infantil](#)
[Baixar livros de Matemática](#)
[Baixar livros de Medicina](#)
[Baixar livros de Medicina Veterinária](#)
[Baixar livros de Meio Ambiente](#)
[Baixar livros de Meteorologia](#)
[Baixar Monografias e TCC](#)
[Baixar livros Multidisciplinar](#)
[Baixar livros de Música](#)
[Baixar livros de Psicologia](#)
[Baixar livros de Química](#)
[Baixar livros de Saúde Coletiva](#)
[Baixar livros de Serviço Social](#)
[Baixar livros de Sociologia](#)
[Baixar livros de Teologia](#)
[Baixar livros de Trabalho](#)
[Baixar livros de Turismo](#)